

DT4-B281

パーツブック

PARTS BOOK

TEILEKATALOG

LIVRE DES PIÈCES

LIBRO DE REFERENCIA DE PIEZAS

4本針二重環縫ミシン

FOUR NEEDLE DOUBLE CHAIN STITCHER

4-NADEL-FLACHBETT-DOPPELKETTENSTICHMASCHINE MIT PULLER

BASE PLANE-POINT DE CHAINETTE DOUBLE 4 AIGUILLES

RECUBREIDORA DE CUATRO AGUJAS INDEPENDIENTES, CADENETA

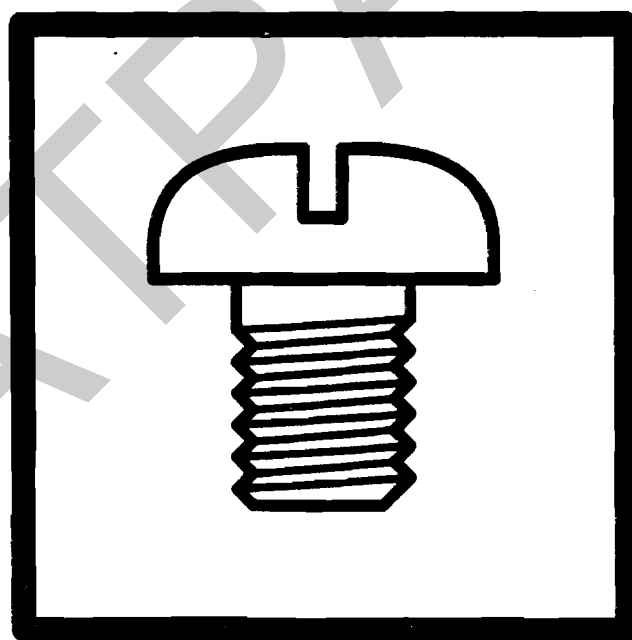

P281401

brother®

Conversion Parts

- 1 off 12-470 Needle Holder 9 Needle ¼” spacing
- 1 off 14-470 Needle Plate 9 Needle ¼” spacing
- 1 off 15-470 Feed Dog 9 Needle ¼” spacing
- 1 off 17-470 Presser Foot 9 Needle ¼” spacing
- 1 off 18-470 Retainer Holder 9 Needle ¼” spacing
- 2 off 19-413 Looper Holder 2 Loopers
- 4 off 19-431 Loopers
- 4 off 19-437 Retainers
- Recommended needle UY113GS size 140

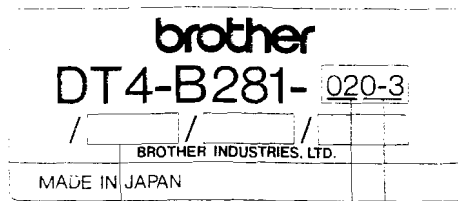

D

A

B

C

A	仕 様 Specifications
00	地縫(プーラ無し) Plain stitching (w/o puller)
02	ゴム付け(下ゴム送り装置付、プーラ付) For elastic gathered waistbands (with bottom metering device and puller)
04	前立て(プーラ付) For shirtfronts (w/ puller)
05	腰裏付け(プーラ付)
06	For waistbands (w/ puller)

D	装 置 Devices
TC1	エア式テープカッター装置 Air type tape cutter
TC3	電磁式テープカッター装置 Solenoid type tape cutter

B	C	針幅(インチ) Needle gauge (inch)
0	1	3/4
0	2	1
0	3	1 1/8
0	4	1 1/4
0	5	1 1/2
0	6	1/4 - 1 - 1/4
0	7	3/16 - 7/8 - 3/16
0	8	1/4 - 3/4 - 1/4
0	9	1/4 - 1/2 - 1/4
1	0	3/16 - 1 - 3/16
1	1	3/16 - 3/4 - 3/16

Notes for using this parts book

1. This book is applicable to sewing machines which have the same plate number as shown on the cover of this book (or correction sheet).
2. This book was prepared based on information available in January 1994.
3. Parts are subject to changes in design without prior notice.
4. Parts supplied as complete assemblies are circled by a dotted line [] .
5. Non-standard parts are indicated with

000
020

 . Numbers inside the line indicate the subclass.
6. Check the gauge parts list (page 31) if there is an asterisk * in the parts code or remarks column.

CONTENTS

A. Machine body	1
B. Upper shaft and needle bar mechanism	3
C. Presser foot mechanism	5
D. Feed mechanism	7
E. Lower shaft mechanism	9
F. Looper mechanism	11
G. Lubrication	13
H. Thread tension	15
J. Retainer mechanism	17
K. Puller device mechanism (020,040,041,050,051,060)	19
L. Lower rubber feed mechanism(020)	23
M. Gauge parts	25
N. Lapper mechanism <option parts>	25
Z1. Accessories	27
Z2. Accessories	29
GAUGE PARTS LIST	31~35
OPTION PARTS	36
INDEX	37~40

Hinweise zur Verwendung dieser Teilleiste

1. Dieses Buch bezieht sich auf die Nähmaschinen mit derselben Kennungsnummer wie auf diesem Buchumschlag (oder auf dem Korrekturblatt).
2. Dieses Buch basiert auf den Informationen vom Januar 1994.
3. Modelländerungen sind vorbehalten.
4. Die Teile, die als kompletter Satz geliefert werden, sind mit einer [] gestrichelten Linie umrandet.
5. Nicht-Standardteile werden mit

000
020

 bezeichnet. Mit den Zahlen innerhalb der Linie wird die Unterklasse angegeben.
6. Falls beim Teilecode oder in der Kolonne Bemerkungen ein Asteriskus * vorhanden ist, in der Liste für Lehren auf Seite 31 nachschlagen.

INHALTSVERZEICHNIS

A. Maschinengehäuse	1
B. Obere Welle und Nadelstangenvorrichtung	3
C. Stoffdrückerfuß	5
D. Transportvorrichtung	7
E. Untere Welle	9
F. Greifer	11
G. Schmierung	13
H. Fadenspannung	15
J. Haltevorrichtung	17
K. Ziehvorrichtung <020,040,041,050,051,060>	19
L. Untere gummibandzuführungsvorrichtung <020>	23
M. Lehren	25
N. Falz-mechanismus <sonderzubehör>	25
Z1. Zubehör	27
Z2. Zubehör	29
LEHRENLISTE	31~35
SONDERZUBEHÖR	36
VERZEICHNIS	37~40

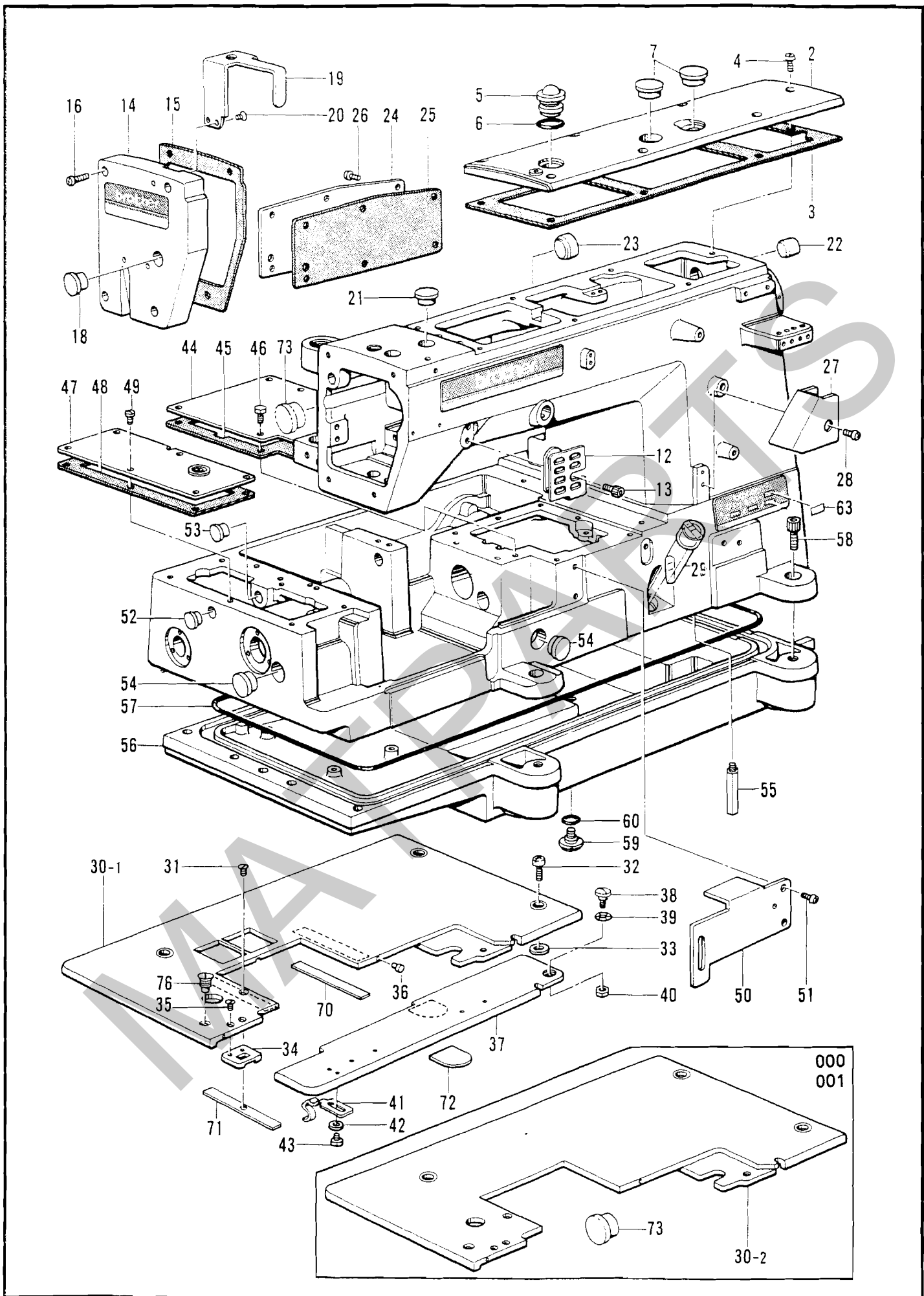

A. 主体関係 / Machine body / Maschinengehäuse / Corps de la machine / Cuerpo de la máquina

REF.NO.	CODE	Q'TY	ヒンメイ	NAME OF PARTS	RM
2	S12703001	1	ウワフタ	TOP COVER	
3	S08628000	1	ウワフタパツキン	TOP COVER PACKING	
4	062681012	7	ナベコ437-40X10	SCREW, PAN M4.37-40X10	
5	S02606000	1	ユリヨウケイマド	OIL GAUGE WINDOW	
6	081014670	1	OリングPW14	O RING,PW14	
7	159150009	2	カマジクメクラセン	OIL CAP	
12	S13811009	1	ハリイトクリカバー	NEEDLE THREAD TAKE-UP COVER	
13	018060822	1	アナボルト6X8	BOLT, SOCKET M6X8	
14	S12961001	1	メンイタ	FACE PLATE	
15	S08631000	1	メンイタパツキン	FACE PLATE PACKING	
16	062681612	4	ナベコ437-40X16	SCREW, PAN M4.37-40X16	
18	117934009	1	メクラセン	OIL CAP	
19	S08632009	1	ハリボウテンビンカバー	NEEDLE BAR TAKE-UP COVER	
20	102843004	2	サラネジ3.57	SCREW, FLAT M3.57	
21	104449009	1	メクラセン	OIL CAP	
22	S00313009	1	メクラセン	OIL CAP	
23	140066009	1	メクラセン	OIL CAP	
24	S12705009	1	ガワイト	REAR COVER	
25	S12706000	1	ガワイトパツキン	REAR COVER PACKING	
26	062680812	6	ナベコ437-40X8	SCREW, PAN M4.37-40X8	
27	S13817001	1	シタイトカバー	LOWER THREAD COVER	
28	062680812	1	ナベコ437-40X8	SCREW, PAN M4.37-40X8	
29	148084001	1	オイルゲージマド	OIL GAUGE WINDOW	
30-1	S12707001	1	クロスプレート	CLOTH PLATE	
31	117143003	1	サラネジ4.37	SCREW, FLAT M4.37	
32	062681012	3	ナベコ437-40X10	SCREW, PAN M4.37-40X10	
33	S08639000	3	クロスプレートパツキン	CLOTH PLATE PACKING	
34	S12708001	1	バネトメイタ	SPRING SET PLATE	
35	102843004	2	サラネジ3.57	SCREW, FLAT M3.57	
36	S12709000	2	クッション	CUSHION	
37	S12710001	1	ラツパードダイ	LAPPER BASE	
38	454631001	1	ダンネジ4.37	STUD SCREW 4.37	
39	120265001	5	ナミバネザガネ	WAVE SPRING WASHER	
40	021680212	1	ナツト2シユ4.37	NUT, 2 M4.37	
41	S12711101	1	トメバネ	SET SPRING	
42	025350132	2	ヒラザガネシヨウ	WASHER, PLAIN S 3.5	
43	062670412	2	ナベコ357-40X4	SCREW, PAN M3.57-40X4	
44	S12712001	1	ベッドウワカバー	BED TOP COVER	
45	S12713000	1	ベッドウワカバーパツキン	BED TOP COVER PACKING	
46	117516001	7	ボルト4.37	BOLT, M4.37	
47	S12714001	1	オクリキコウカバー	FEED MECHANISM COVER	
48	S12715000	1	オクリキコウカバーパツキン	FEED MECHANISM COVER PACKING	
49	106629002	6	シメネジ4.37	SCREW 4.37	
50	S12716009	1	リテーナウデカバー	RETAINER ARM COVER	
51	062680612	2	ナベコ4.37-40X6	SCREW, PAN M4.37-40X6	
52	S12717009	1	メクラセン	OIL CAP	
53	104821009	1	メクラセン	OIL CAP	
54	150756009	2	メクラセン	OIL CAP	
55	151059001	4	ホンタイシチユウ	MACHINE BODY LEG	
56	S08674000	1	アブラウケ	OIL RESERVOIR	
57	S08675000	1	Oリング	O RING	
58	018081622	5	アナボルト8X16	BOLT, SOCKET M8X16	
59	110641002	1	ダンネジ9.52	STUD SCREW 9.52	
60	109203001	1	Oリング	O RING	
63	※	1	シヨウラベル	LABEL	
70	S14195000	1	クッションA	CUSHION (A)	
71	S14196000	1	クッションB	CUSHION (B)	
72	S14197000	1	クッションC	CUSHION (C)	
76	158384001	1	サラネジ4.37	SCREW, FLAT M4.37	
<000,001>	<プーラ無し用 / FOR W/O PULLER>				
30-2	S15165001	1	クロスプレート	CLOTH PLATE	
73	S15166009	1	メクラセン	OIL CAP	

B. 上軸・針棒関係 / Upper shaft and needle bar mechanism / Obere Welle und Nadelstangenvorrichtung / Mécanisme de arbre supérieur et barra à aiguille / Mecanismo del eje superior y la barra de aguja

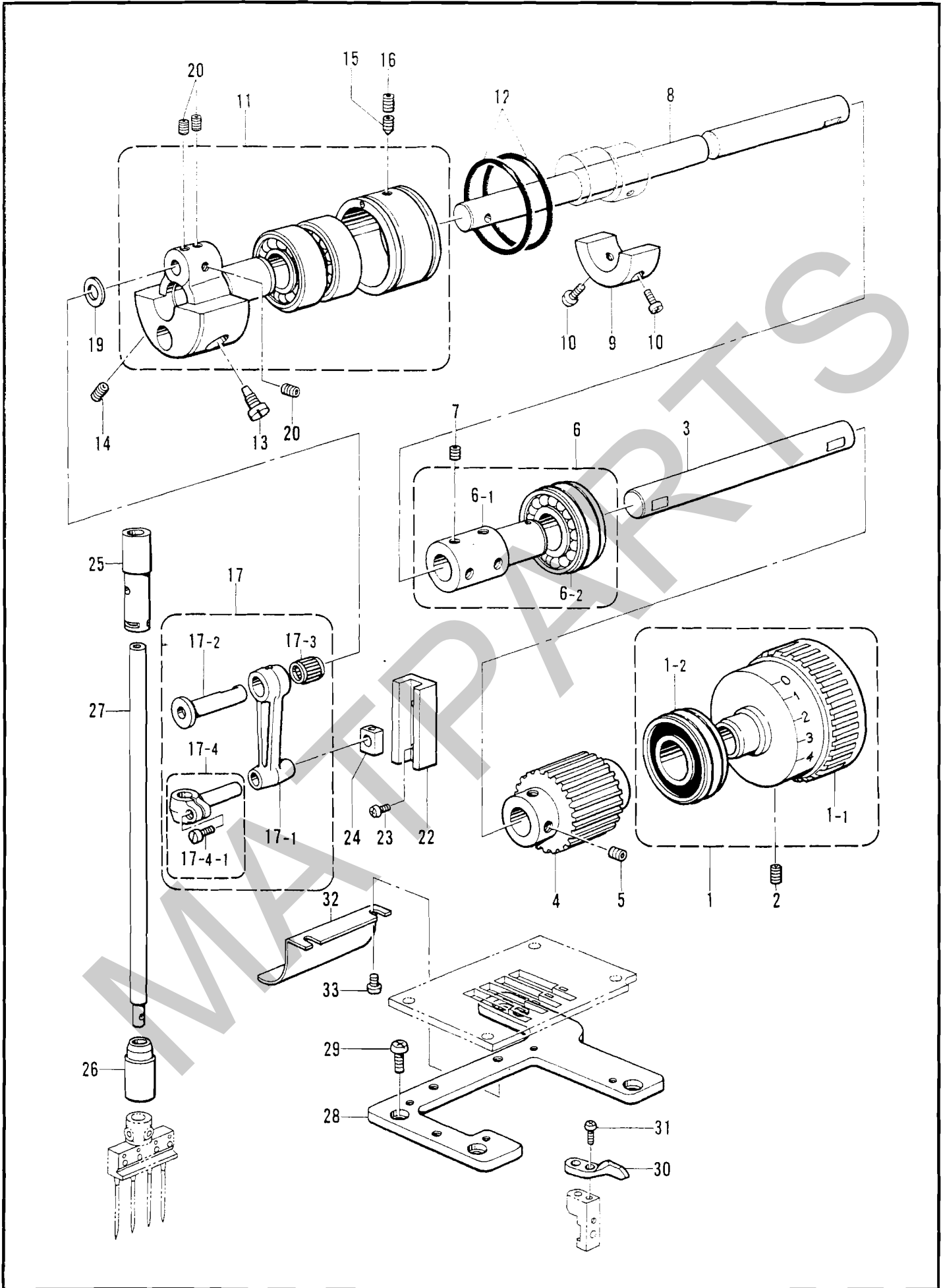

B. 上軸・針棒関係 / Upper shaft and needle bar mechanism / Obere Welle und Nadelstangenvorrichtung / Mécanisme de arbre supérieur et barra à aiguille / Mecanismo del eje superior y la barra de aguaja

REF.NO.	CODE	Q'TY	ヒンメイ	NAME OF PARTS	RM
1	S12721009	1	フーリクミ	PULLEY ASSY	
1-1	S12722009	1	フーリ	PULLEY	
1-2	S14621001	1	タマジクウケ6204LLB	BALL BEARING, 6204LLB	
2	014770622	2	アナトメネジ6.35クボミ	SET SCREW, SOCKET (CP) M6.35	
3	S08682001	1	ウワジクR	UPPER SHAFT (R)	
4	S08683000	1	タイミングプーリU	TIMING PULLEY (U)	
5	014770622	4	アナトメネジ6.35クボミ	SET SCREW, SOCKET (CP) M6.35	
6	S08684101	1	ツギテLクミ	JOINT (L) ASSY	
6-1	S08685001	1	ツギテL	JOINT (L)	
6-2	S08686101	1	タマジクウケ6204LU	BALL BEARING, 6204LU	
7	014770622	4	アナトメネジ6.35クボミ	SET SCREW, SOCKET (CP) M6.35	
8	S12724001	1	ウワジクL	UPPER SHAFT (L)	
9	S08688001	1	ウエイト	WEIGHT	
10	062711012	2	ナベコ476-32X10	SCREW, PAN M4.76-32X10	
11	S12725101	1	ハリボウ克蘭ククミ	NEEDLE BAR CRANK ASSY	
12	081046870	2	OリングS46	O RING, S46	
13	104464001	1	シメネジ7.14	SCREW 7.14	
14	014770622	1	アナトメネジ6.35クボミ	SET SCREW, SOCKET (CP) M6.35	
15	118853001	1	アナトメネジ5.95	SET SCREW, SOCKET M5.95	
16	014760622	1	アナトメネジ5.95	SET SCREW, SOCKET (CP) M5.95	
17	S08692101	1	ハリボウレンカンクミ	THREAD TAKE-UP LEVER ASSY	
17-1	S08693001	1	ハリボウレンカン	THREAD TAKE-UP LEVER	
17-2	S08694001	1	ハリボウレンカンジク	THREAD TAKE-UP LEVER SHAFT	
17-3	S09120001	1	ニードルジクウケ	NEEDLE ROLLER BEARING	
17-4	S30086001	1	ハリボウダキクミ	NEEDLE BAR CLAMP ASSY	
17-4-1	100064005	1	シメネジ3.57	SCREW 3.57	
19	107153001	1	ザガネ	WASHER	
20	152718001	3	アナトメネジ5.95	SET SCREW, SOCKET M5.95	
22	145688000	1	ハリボウアンナイ	NEEDLE BAR GUIDE	
23	062670612	2	ナベコ357-40X6	SCREW, PAN M3.57-40X6	
24	102630001	1	ハリボウアンナイカクコマ	NEEDLE BAR GUIDE SLIDE BLOCK	
25	S08696000	1	ハリボウメタルU	NEEDLE BAR BUSH (U)	
26	S16226000	1	ハリボウメタルD	NEEDLE BAR BUSH (D)	
27	S12729001	1	ハリボウ	NEEDLE BAR	
28	S12730001	1	ハリイタササエイタ	NEEDLE PLATE SUPPORT PLATE	
29	062680812	4	ナベコ437-40X8	SCREW, PAN M4.37-40X8	
30	S12731001	4	ハリウケ	NEEDLE GUARD	
31	062660712	4	ナベコ318-40X7	SCREW, PAN M3.18-40X7	
32	S12720001	1	シタローラガード	LOWER ROLLER GUARD	
33	062680512	2	ナベコ437-40X5	SCREW, PAN M4.37-40X5	

C. 押工関係 / Presser foot mechanism / Stoffdrückerfuß /
Mécanisme de pied presseur / Mecanismo de la prensa tela

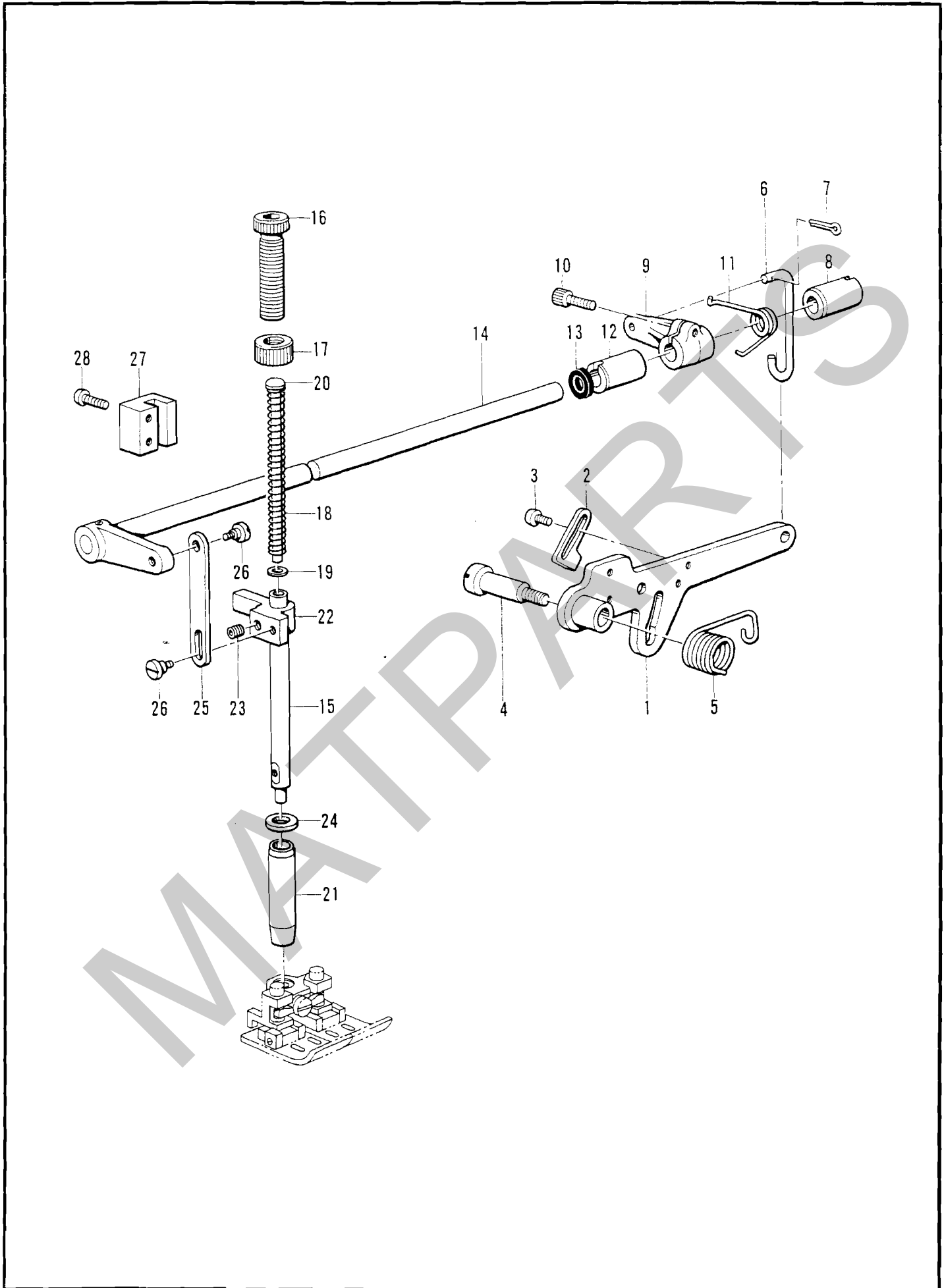

C. 押工関係 / Presser foot mechanism / Stoffdrückerfuß / Mécanisme de pied presseur /
Mecanismo de la prensa tela

REF.NO.	CODE	Q'TY	ヒンメイ	NAME OF PARTS	RM
1	S08767001	1	オサエアゲレバーR	PRESSER BAR LIFTER LEVER (R)	
2	S08768001	1	オサエアゲストツハ	PRESSER BAR LIFTER LEVER STOPPER	
3	060680712	2	バインド437-40X7	SCREW, BIND M4.37-40X7	
4	148372001	1	ダンネジ7.94	STUD SCREW 7.94	
5	143325001	1	オサエアシアゲレバーバネ	SPRING	
6	S08769001	1	オサエアゲリンク	PRESSER BAR LIFTER LINK	
7	110793001	1	ワリピン	PIN, COTTER	
8	155220000	1	ホジヨアツメタルR	AUTO PRESSER ARM BUSH (R)	
9	154956001	1	オサエアシアゲMレバー	PRESSER FOOT LIFTER INSIDE LEVER	
10	018771432	1	アナボルト635-40X14	BOLT, SOCKET M6.35-40X14	
11	154957001	1	オサエアゲMレバーバネ	SPRING	
12	S08770000	1	ジクメタル	SHAFT BUSH	
13	155539000	1	ダストシール	DUST SEAL	
14	S08771001	1	オサエアゲレバーLクミ	PRESSER BAR LIFTER LEVER (L) ASSY	
15	S08774001	1	オサエボウ	PRESSER BAR	
16	S31012001	1	オサエチヨウセツネジ	ADJUST SCREW	
17	S31013001	1	チヨウセツネジツマミナツト	NUT	
18	141728001	1	オサエバネ	SPRING	
19	140407001	1	ザガネ	WASHER	
20	141208001	1	オサエバネアンナイ	SPRING GUIDE	
21	145472001	1	オサエボウメタル	PRESSER BAR BUSH	
22	S00879001	1	オサエボウダキ	PRESSER BAR CLAMP	
23	014760622	1	アナトメネジ5.95	SET SCREW, SOCKET (CP) M5.95	
24	154596000	1	イトキリカムレバークッション	CUSHION	
25	S08776001	1	オサエアゲイタ	PRESSER BAR LIFTER PLATE	
26	S08777001	2	ダンネジ4.37	STUD SCREW, M4.37	
27	S08775000	1	オサエボウアンナイ	PRESSER BAR GUIDE	
28	062681412	2	ナベコ437-40X14	SCREW, PAN M4.37-40X14	

D. 送り関係 / Feed mechanism / Transportvorrichtung /
 Mécanisme de l'entraînement / Mecanismo de la alimentación

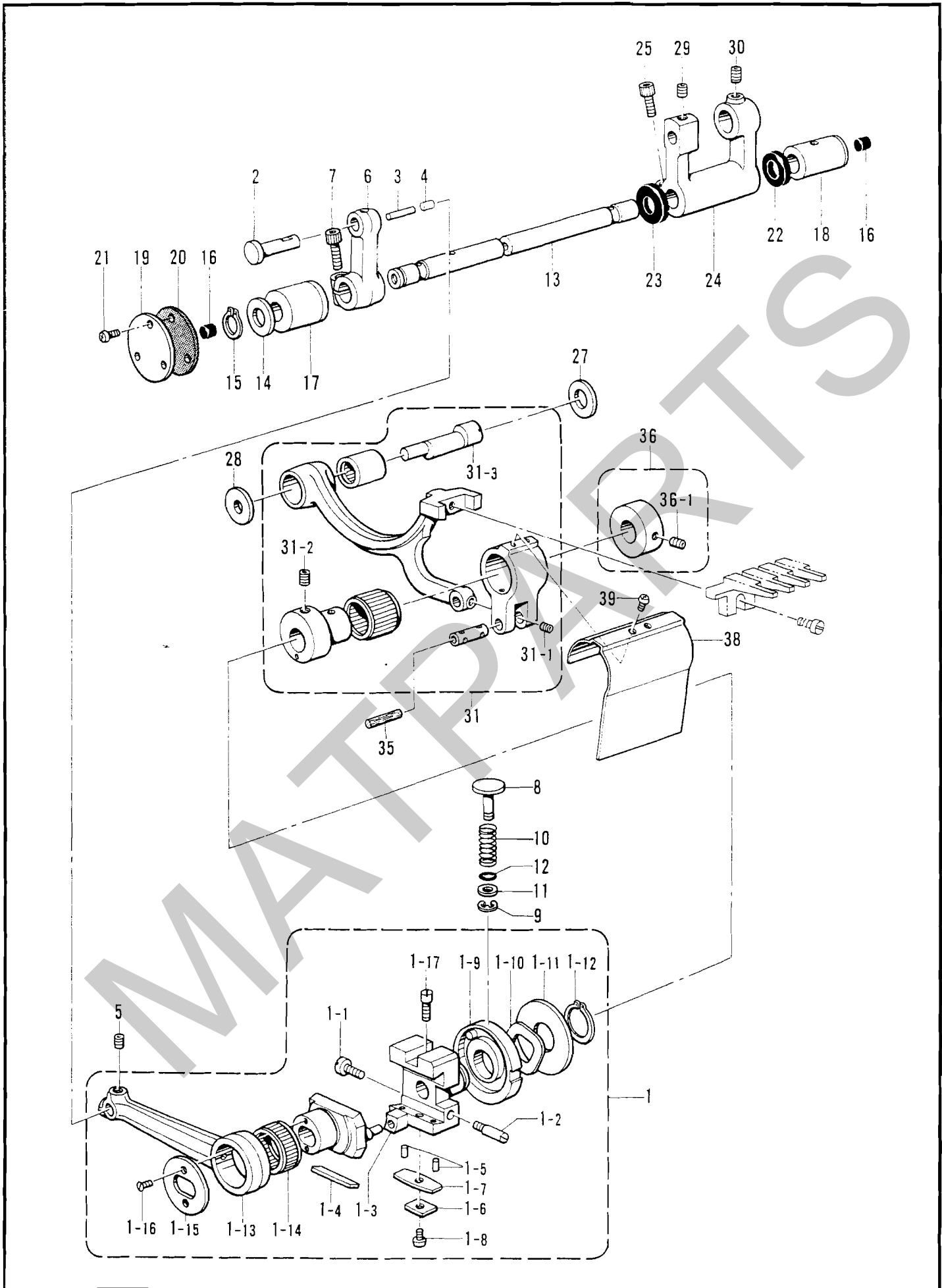

D. 送り関係 / Feed mechanism / Transportvorrichtung /

Mécanisme de l'entraînement / Mecanismo de la alimentación

REF.NO.	CODE	Q'TY	ヒンメイ	NAME OF PARTS	RM
1	S12732201	1	ヘンシンリンクミ	ECCENTRIC WHEEL ASSY	
1-1	S16498001	1	シメネジ4.37	SCREW, M4.37	
1-2	145663001	1	トメネジ4.37	SET SCREW, M4.37	
1-3	140165001	1	チヨウセツピンカクコマ	SLIDE BLOCK	
1-4	146401001	1	ジブ	GIB	
1-5	146402001	2	ジブオサエピン	PIN	
1-6	146403001	1	ジブオサエイタバネS	PLATE SPRING (S)	
1-7	146404001	1	ジブオサエイタバネL	PLATE SPRING (L)	
1-8	062660512	1	ナベコネジ318-40X5	SCREW, PAN M3.18-40X5	
1-9	S12733001	1	ヘンシンチヨウセツカムクミ	ECCENTRIC WHEEL ADJUST CAM ASSY	
1-10	144055001	1	ナミバネ	WAVE SPRING	
1-11	146529001	1	ザガネ	WASHER	
1-12	048150143	1	トメワジクヨウC15	RETAINING RING, C15	
1-13	S12735001	1	オクリロツド	FEED ROD	
1-14	146531001	1	ニードルジクウケ20	NEEDLE ROLLER BEARING 20	
1-15	140176001	1	オクリロツドオサエイタ	FEED ROD PRESSER PLATE	
1-16	117517003	2	サラネジ2.38	SCREW, FLAT M2.38	
1-17	100025002	2	シメネジ4.76	SCREW 4.76	
2	146532001	1	オクリロツドピン	PIN	
3	147318000	1	ピン	PIN	
4	140326009	1	ゴムセン	OIL CAP	
5	100251001	1	トメネジ6.35	SET SCREW, M6.35	
6	S12736001	1	オクリウデ	FEED ARM	
7	018061622	1	アナホルト6X16	BOLT, SOCKET M6X16	
8	S12737001	1	プツシユボタン	PUSH BUTTON	
9	048040342	1	トメワE4	RETAINING RING, E4	
10	S08871001	1	ボタンジクバネ	SPRING	
11	153484001	1	ザガネ4.76	WASHER 4.76	
12	081003670	1	OリングPW3	O RING, PW3	
13	S12738001	1	オクリジク	FEED SHAFT	
14	142628001	1	スイハイオクリ克蘭クリング	FEED ROCK CRANK RING	
15	048110142	1	トメワジクヨウC11	RETAINING RING, C11	
16	140327001	2	ゴムセン	OIL CAP	
17	146539000	1	オクリジクメタルL	FEED SHAFT BUSH (L)	
18	141404000	1	カムジクドダイメタル	FEED CAM SHAFT BRACKET BUSH	
19	S12740001	1	オクリジクメタルLフタ	FEED SHAFT BUSH (L) CAP	
20	155145000	1	パツキン	PACKING	
21	062670812	3	ナベコ3.57-40X8	SCREW, PAN M3.57-40X8	
22	S12741000	1	ダストシール	DUST SEAL	
23	155247000	1	ダストシール	DUST SEAL	
24	S12742001	1	オクリダイウデ	FEED BAR ARM	
25	S07959001	2	アナホルト476-32X14	BOLT, SOCKET M4.76-32X14	
27	S09260001	1	スラストリングA	THRUST RING (A)	
28	151090001	1	スラストザガネ	THRUST WASHER	
29	014680622	1	アナトメネジ4.37クボミ	SET SCREW, SOCKET (CP) M4.37	
30	014680422	1	アナトメネジ4.37クボミ	SET SCREW, SOCKET (CP) M4.37	
31	S14185001	1	オクリダイヘンシンリンクミ	FEED BRACKET ECCENTRIC WHEEL ASSY	
31-1	148294001	1	アナトメネジ3.57クボミ	SET SCREW, SOCKET (CP) M3.57	
31-2	014680622	2	アナトメネジ4.37クボミ	SET SCREW, SOCKET (CP) M4.37	
31-3	S12743001	1	オクリダイウデジク	FEED BAR ARM SHAFT	
35	147691000	1	フェルト	FELT	
36	S13813001	1	セツトカラーネジツキ	SET COLLAR WITH SCREW	
36-1	014770622	2	アナトメネジ6.35クボミ	SET SCREW, SOCKET (CP) M6.35	
38	S14170101	1	オクリロツドカバー	FEED ROD COVER	
39	S14314001	2	ナベコ357-40X4	SCREW, PAN M3.57-40X4	

E. 下軸関係 / Lower shaft mechanism / Untere Welle /
Mécanisme de l'arbre inférieur / Mecanismo del eje inferior

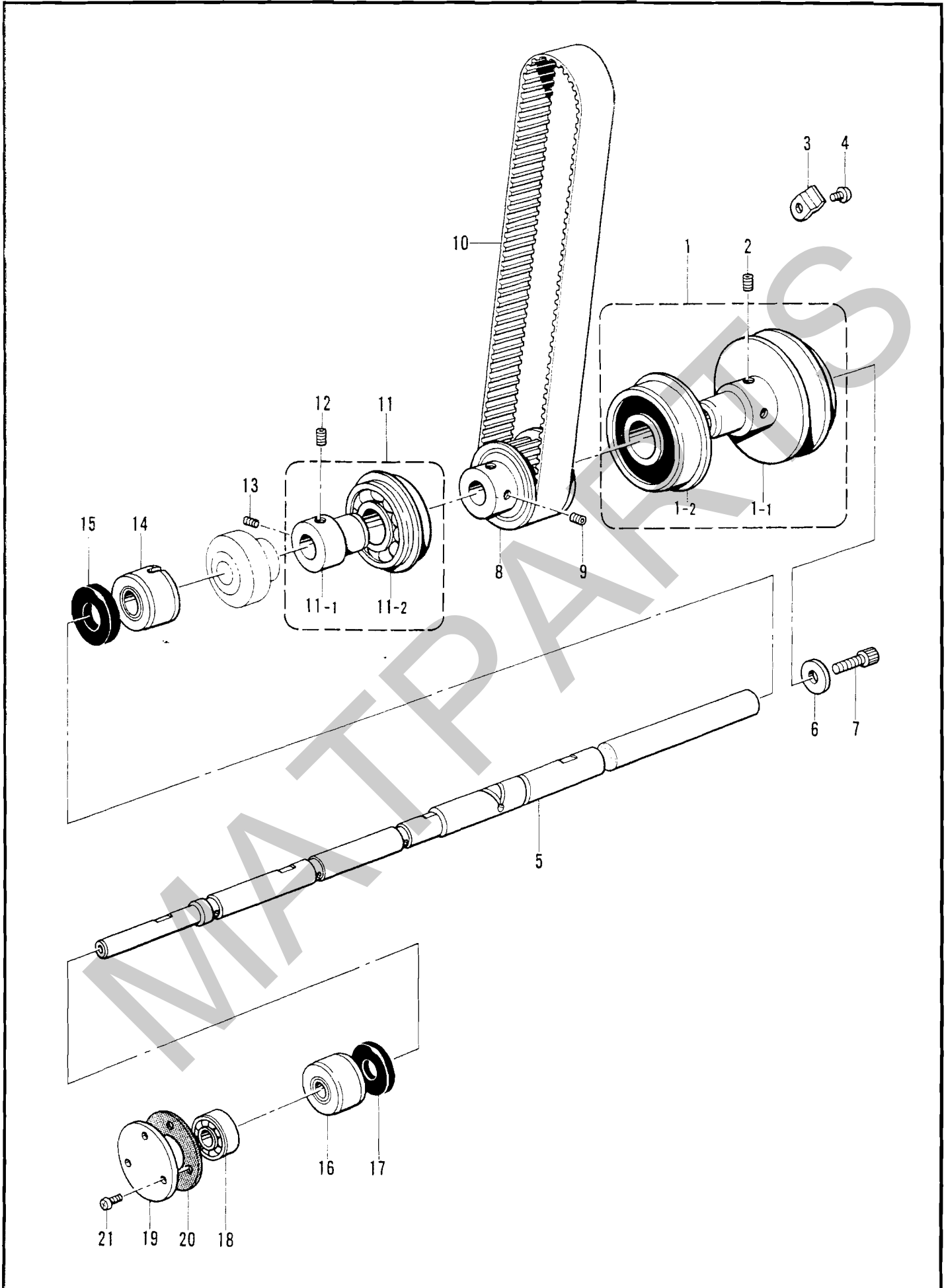

118-281-305

E. 下軸関係 / Lower shaft mechanism / Untere Welle /
 Mécanisme de l'arbre inférieur / Mecanismo del eje inferior

REF.NO.	CODE	Q'TY	ヒンメイ	NAME OF PARTS	RM
1	S08889101	1	Vベルトプーリクミ	V-BELT PULLEY ASSY	
1-1	S08890001	1	Vベルトプーリ	V-BELT PULLEY	
1-2	S14622001	1	タマジクウケ6304VV	BALL BEARING, 6304VV	
2	014780622	2	アナトメネジ6.35クホミ	SET SCREW, SOCKET (CP) M6.35	
3	153734001	2	アームササエイタバネ	PLATE SPRING	
4	062680612	2	ナベコ4.37-40X6	SCREW, PAN M4.37-40X6	
5	S12807001	1	シタジク	LOWER SHAFT	
6	154886001	1	ザガネ	WASHER	
7	018771432	1	アナボルト635-40X14	BOLT, SOCKET M6.35-40X14	
8	S08892001	1	タイミングプーリDクミ	TIMING PULLEY (D) ASSY	
9	014770622	2	アナトメネジ6.35クホミ	SET SCREW, SOCKET (CP) M6.35	
10	★ S12806001	1	タイミングベルト	TIMING BELT	
10	★ S12806002	1	タイミングベルト	TIMING BELT	
10	★ S12806003	1	タイミングベルト	TIMING BELT	
11	S08896101	1	タマジクウケクミ	BALL BEARING ASSY	
11-1	S08897001	1	タマジクウケブシユ	BALL BEARING BUSH	
11-2	S14623001	1	タマジクウケ6204DV	BALL BEARING, 6204DV	
12	014770622	1	アナトメネジ6.35クホミ	SET SCREW, SOCKET (CP) M6.35	
13	112684001	1	トメネジ6.35	SET SCREW, M6.35	
14	S12811000	1	シタジクメタルRクミ	LOWER SHAFT BUSH (R) ASSY	
15	S07468000	1	オイルシール	OIL SEAL	
16	S12814000	1	シタジクメタルLクミ	LOWER SHAFT BUSH (L) ASSY	
17	S12817000	1	ダストシール	DUST SEAL	
18	072600000	1	タマジクウケ6000	BALL BEARING 6000	
19	S12818001	1	ベアリングフタ	BEARING COVER	
20	143312000	1	ベアリングフタパツキン	BEARING COVER PACKING	
21	062670812	3	ナベコ3.57-40X8	SCREW, PAN M3.57-40X8	

★印はアームベッド上面のテーキンに合わせてご選択下さい。(取扱説明書タイミングベルト交換の仕方をご参照ください。)

Select parts marked with a star (★) according to the index on the arm bed top. (Refer to timing belt replacement in the instruction manual.)

Die mit dem Zeichen (★) markierten Teile entsprechend dem an der Oberseite des Armbetts angegebenen Index auswählen. (Siehe Ersetzen des Synchronriemens in der Bedienungsanleitung.)

Sélectionner les pièces indiquées par une étoile (★) selon l'index situé sur le plateau du bras. (Se reporter à la section du manuel d'instructions concernant le remplacement de la courroie de synchronisation.)

Las piezas marcadas con un asterisco (★) se deben seleccionar de acuerdo al índice de la parte superior de la mesa del brazo. (Consultar la sección sobre el cambio de la correa de distribución en el manual de instrucciones.)

F. ルーバー関係 / Looper mechanism / Greifer /
Mécanisme des griffes / Mecanismo del presilladora

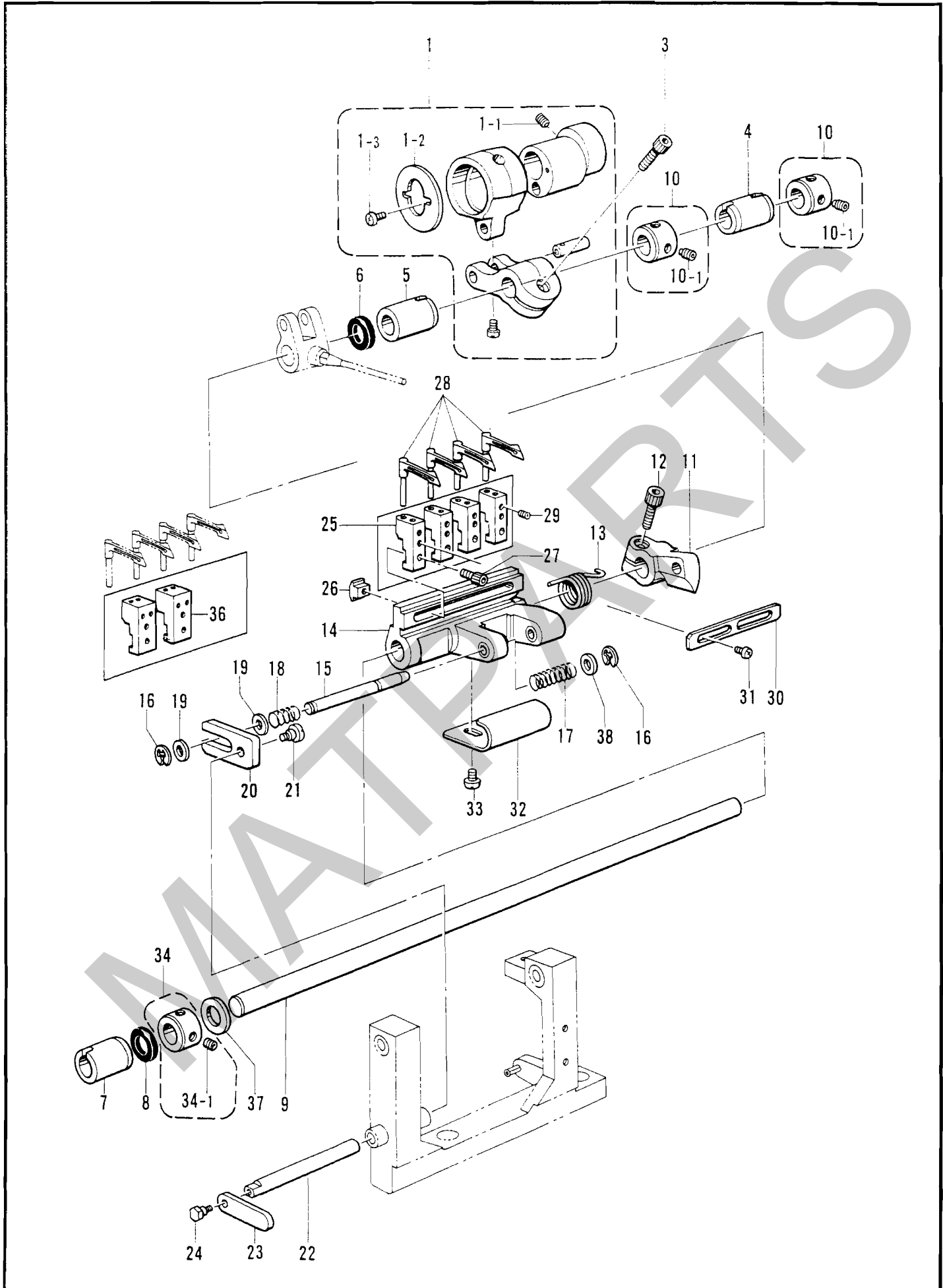

F. ルーパー関係 / Loooper mechanism / Greifer /
 Mécanisme des griffes / Mecanismo del presilladora

REF.NO.	CODE	Q'TY	ヒンメイ	NAME OF PARTS	RM
1	S12819201	1	ルーパーハブシンリンクミ	LOOPER ECCENTRIC WHEEL ASSY	
1-1	014680622	2	アナトメネジ4.37クボミ	SET SCREW, SOCKET (CP) M4.37	
1-2	S12821001	1	レンカンオサエ	CONNECTING ROD PRESSER	
1-3	062630612	2	ナベコ238-56X6	SCREW, PAN M2.38-56X6	
3	018061622	1	アナボルト6X16	BOLT, SOCKET M6X16	
4	S12825000	1	ルーパーバジクメタルR	LOOPER SHAFT BUSH (R)	
5	S12826100	1	ルーパーバジクメタルM	LOOPER SHAFT BUSH (M)	
6	S12827000	1	ダストシール	DUST SEAL	
7	S12828000	1	ルーパーバジクメタルL	LOOPER SHAFT BUSH (L)	
8	S12741000	1	ダストシール	DUST SEAL	
9	S12829001	1	ルーパーバジク	LOOPER SHAFT	
10	159441001	2	セツトカラークミ	SET COLLAR ASSY	
10-1	014760622	2	アナトメネジ5.95	SET SCREW, SOCKET (CP) M5.95	
11	S12830001	1	ホルダフレームレバー	HOLDER FRAME LEVER	
12	018061622	1	アナボルト6X16	BOLT, SOCKET M6X16	
13	S12831001	1	ルーパーバタオシバネ	SPRING	
14	S12832001	1	ルーパーホルダフレーム	LOOPER HOLDER FRAME	
15	S12833001	1	テーパージク	TAPER SHAFT	
16	048050342	2	トメワE5	RETAINING RING, E5	
17	S12834001	1	テーパジクバネ	SPRING	
18	S12835001	1	フタマタイタオサエバネ	SPRING	
19	025060132	2	ヒラザガネシヨウ6	WASHER, PLAIN S 6	
20	S12836001	1	フタマタイタ	FEED FORKED PLATE	
21	147476001	1	ダンネジ4.37	STUD SCREW, M4.37	
22	S12837001	1	ルーパーバタオシジク	LOOPER SHAFT	
23	S12838001	1	ヒキイタ	PULLING PLATE	
24	159113001	1	ダンネジ3.18	STUD SCREW, M3.18	
26	S12840001	4	ルーパーホルダナツト	LOOPER HOLDER NUT	
27	018301222	4	アナボルト3X12	BOLT, SOCKET M3X12	
28	S12842001	4	ルーパー	LOOPER	
29	148294001	4	アナトメネジ3.57クボミ	SET SCREW, SOCKET (CP) M3.57	
30	S12843001	1	レンケツイタ	CONNECTING PLATE	
31	060660512	4	バインド318-40X5	SCREW, BIND M3.18-40X5	
32	S12844001	1	シタイトカバー	LOWER THREAD COVER	
33	141544001	2	シメネジ3.18	SCREW, M3.18	
34	S21754001	1	セツトカラークミ	SET COLLAR ASSY	
34-1	152718001	2	アナトメネジ5.95	SET SCREW, SOCKET M5.95	
37	142628001	1	スイヘイオクリクランクリング	FEED ROCK CRANK RING	
38	109893002	1	ザガネ	WASHER	
25	S12839001	4	ルーパーホルダ	LOOPER HOLDER	※
36	S13814001	2	ルーパーホルダ3/16	LOOPER HOLDER 3/16	※

参照番号 Ref.No.	部品コード Parts code	仕様コード Specifications	針幅(インチ) Needle spacing (Inch)	参照番号 Ref.No.	部品コード Parts cod	仕様コード Specifications	針幅(インチ) Needle spacing (Inch)
H-25	S12839001	020-1	3/4	H-36	S13814-001	000-7,040-7, 050-7	3/16-7/8-3/16
		000-2,020-2	1			001-0,041-0, 051-0	3/16-1-3/16
		000-3,020-3 050-3	1 1/8			001-1,041-1, 051-1	3/16-3/4-3/16
		000-4,020-4	1 1/4				
		000-5,020-5	1 1/2				
		000-6,040-6 050-6	1/4-1-1/4				
		000-8,040-8 050-8	1/4-3/4-1/4				
		000-9,020-9	1/4-1/2-1/4				

118-281-306

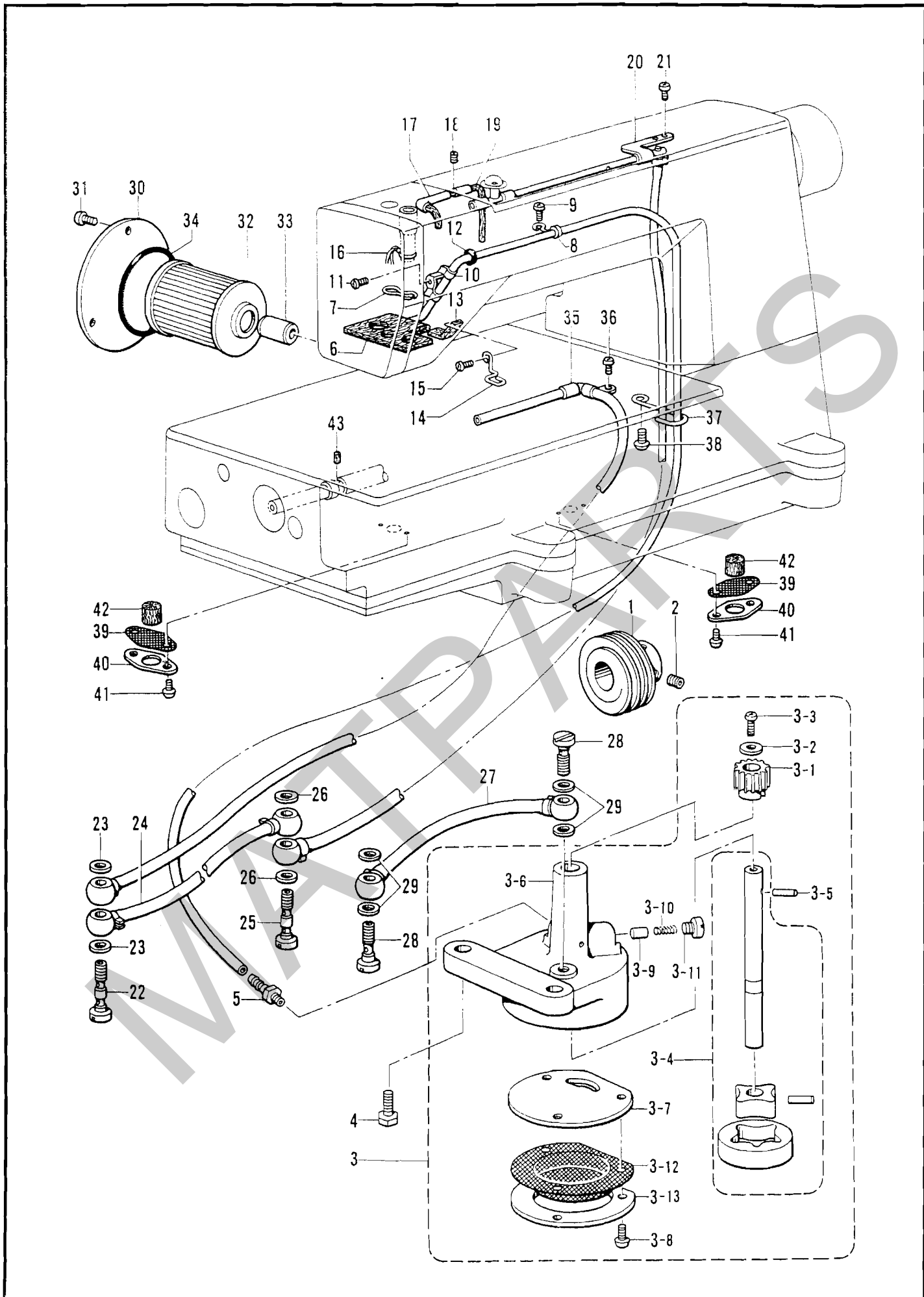

REF.NO.	CODE	Q'TY	ヒンメイ	NAME OF PARTS	RM
1	S08935001	1	ウオーム	WORM	
2	014770622	2	アナトメネジ6.35クボミ	SET SCREW, SOCKET (CP) M6.35	
3	S08936201	1	トロコイドポンプクミ	PUMP ASSY	
3-1	144619000	1	ウオームホイール	WORM WHEEL	
3-2	025350332	1	ヒラザガネダイ3.5	WASHER, PLAIN L 3.5	
3-3	062670812	1	ナベコ3.57-40X8	SCREW, PAN M3.57-40X8	
3-4	S08937101	1	ポンプロータークミ	PUMP INNER ROTER ASSY	
3-5	144622001	1	ミゾツキピンEガタ	DOWEL PIN (E)	
3-6	S08939100	1	ポンプケース	PUMP CASE	
3-7	147527000	1	ポンプフタ	PUMP COVER	
3-8	062671012	3	ナベコ357-40X10	SCREW, PAN M3.57-40X10	
3-9	144875001	1	プランジャー	PLUNGER	
3-10	144876001	1	プランジャーバネ	PLUNGER SPRING	
3-11	112467002	1	シメネジ6.35	SCREW, M6.35	
3-12	147528100	1	ロカモウ	OIL FILTER	
3-13	147529000	1	ロカモウオサエ	OIL FILTER FLANGE	
4	017781412	2	ボルト6.35X14	BOLT, M6.35X14	
5	142359001	1	オイルクチ	OIL FEEDING PIPE	
6	S08940000	1	チューブクミ	OIL TUBE ASSY	
7	145737001	1	フェルトオサエ	FELT SUPPORT	
8	112743001	1	クミヒモササエ	WICK SUPPORT	
9	062670612	1	ナベコ357-40X6	SCREW, PAN M3.57-40X6	
10	151429001	1	チューブホルダ	TUBE HOLDER	
11	062670612	1	ナベコ357-40X6	SCREW, PAN M3.57-40X6	
12	118770001	1	パッキン	PACKING	
13	S08943000	1	カクゴマフェルト	FELT	
14	S08944001	1	フェルトオサエ	FELT SUPPORT	
15	062670612	1	ナベコ357-40X6	SCREW, PAN M3.57-40X6	
16	157840000	1	クミヒモ3X3 (L = 100)	WICK 3X3 (L = 100)	
17	S08945001	1	オイルパイプ	OIL PIPE	
18	014680622	1	アナトメネジ4.37クボミ	SET SCREW, SOCKET (CP) M4.37	
19	S08946000	1	フェルト	FELT	
20	S12845001	1	ロッドオイルパイプUクミ	ROD OIL PIPE (U) ASSY	
21	062670612	2	ナベコ357-40X6	SCREW, PAN M3.57-40X6	
22	112364001	1	ハイユパイプツギテネジ	OIL FEEDING PIPE JOINT SCREW	
23	159476000	2	ザガネ	WASHER	
24	S12846001	1	ビニルチューブクミ	OIL TUBE ASSY	
25	112364001	1	ハイユパイプツギテネジ	OIL FEEDING PIPE JOINT SCREW	
26	159476000	2	ザガネ	WASHER	
27	140779101	1	ビニルチューブクミ	OIL TUBE ASSY	
28	112359001	2	ハイユパイプツギテネジ	OIL FEEDING PIPE JOINT SCREW	
29	159476000	4	ザガネ	WASHER	
30	S12987001	1	オイルフィルターフタ	OIL FILTER CAP	
31	062680812	3	ナベコ437-40X8	SCREW, PAN M4.37-40X8	
32	S08956000	1	オイルフィルター	OIL FILTER	
33	S08957001	1	オイルクチ	OIL FEEDING PIPE	
34	081044070	1	OリングP44	O RING, P44	
35	S12848001	1	ロッドオイルパイプDクミ	ROD OIL PIPE (D) ASSY	
36	062670612	1	ナベコ357-40X6	SCREW, PAN M3.57-40X6	
37	S09125001	1	チューブガイド	OIL TUBE GUIDE	
38	062780812	1	ナベコ635-28X8	SCREW, PAN M6.35-28X8	
39	155294100	2	ロカモウ	OIL FILTER	
40	155295001	2	ロカモウオサエイタ	OIL FILTER FLANGE	
41	062670612	4	ナベコ357-40X6	SCREW, PAN M3.57-40X6	
42	151927001	2	クラッチフェルト	CLUTCH FELT	
43	S12718000	2	ケミカルフェルト	CHEMICAL FELT	

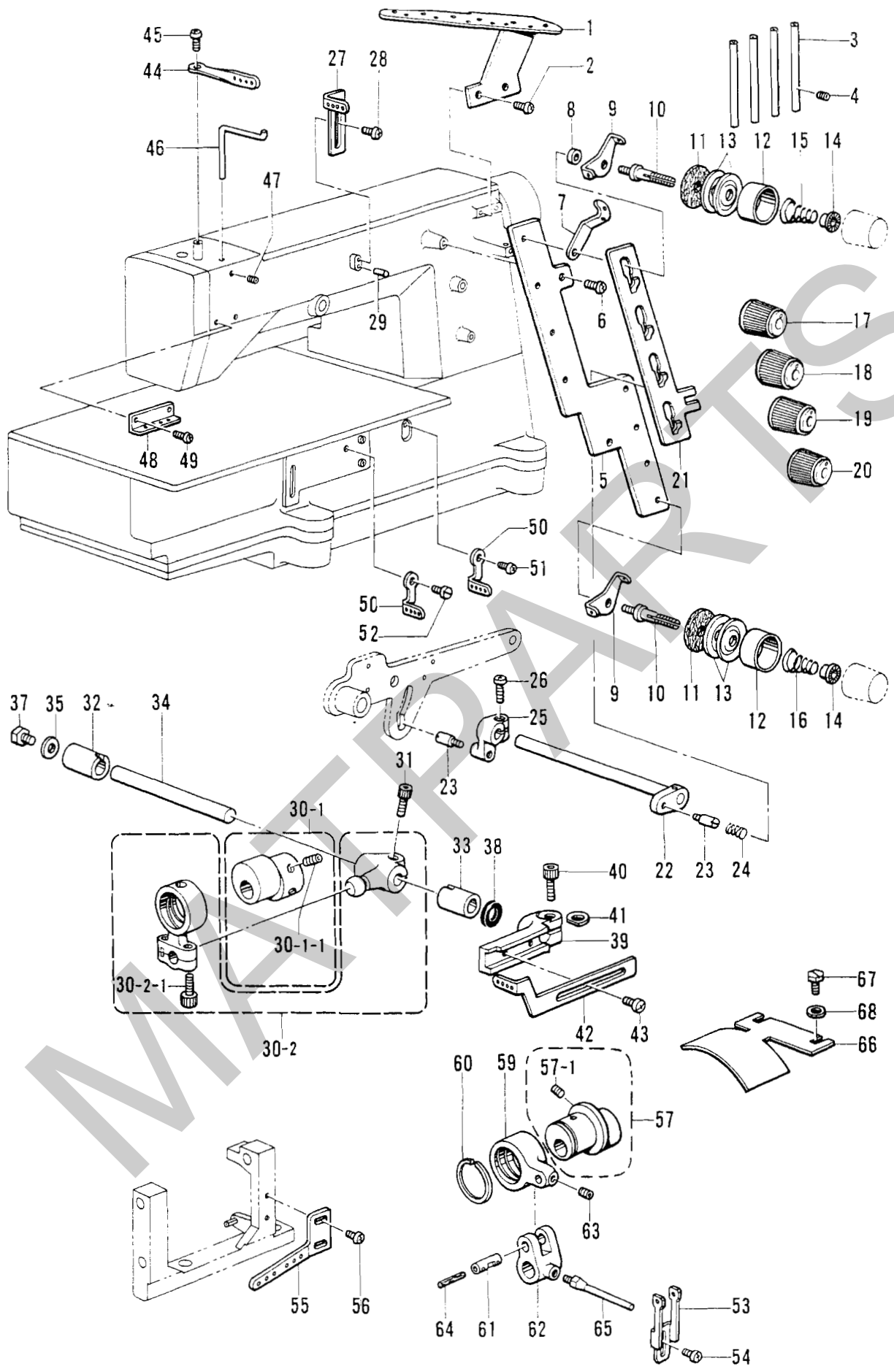

H. 糸調子関係 / Thread tension / Faderspannung / Tension du fil / Tensión del hilo

REF.NO.	CODE	QTY	ヒンメイ	NAME OF PARTS	RM
1	S08961101	1	シユイトアンナイ	MAIN THREAD GUIDE	
2	062680812	2	ナベコ437-40X8	SCREW, PAN M4.37-40X8	
3	150645009	4	イトアンナイハイフル	THREAD GUIDE PIPE (L)	
4	014680422	4	アナトメネジ4.37クボミ	SET SCREW, SOCKET (CP) M4.37	
5	S12871009	1	イトチヨウシダイ	TENSION BASE	
6	062681012	2	ナベコ437-40X10	SCREW, PAN M4.37-40X10	
7	S08963001	4	イトチヨウシダイイトアンナイ	TENSION BASE THREAD GUIDE	
8	S08964001	8	カンザ	SPACER	
9	110813001	8	ハリイトアンナイ	NEEDLE THREAD GUIDE	
10	159574101	8	イトチヨウシボウ	TENSION STUD	
11	110832009	8	イトチヨウシサラフェルト	TENSION DISC FELT	
12	144103009	8	イトチヨウシサラオサエ	TENSION DISC PRESSER	
13	145446001	16	イトチヨウシサラ	TENSION DISC	
14	S30564000	8	チヨウシバネウエザガネ	TENSION SPRING WASHER	
15	144104001	4	ハリイトチヨウシバネ	THREAD TENSION ADJUST SPRING	
16	S12872001	4	ルーパイトチヨウシバネ	TENSION SPRING	
17	S30565003	2	イトチヨウシナツト (アカ)	TENSION NUT (RED)	
18	S30565001	2	イトチヨウシナツト (ミズイロ)	TENSION NUT (LIGHT BLUE)	
19	S30565004	2	イトチヨウシナツト (キイ)	TENSION NUT (YELLOW)	
20	S30565002	2	イトチヨウシナツト (ミドリ)	TENSION NUT (GREEN)	
21	S12873009	1	イトユルメイタ	TENSION RELEASE PLATE	
22	S08966001	1	イトユルメジク	TENSION RELEASE SHAFT	
23	S08967001	2	シメネジ4.76	SCREW, M4.76	
24	118718001	1	オサエボウダキオシバネ	SPRING, COMPRESSION	
25	S08968001	1	イトユルメウデ	TENSION RELEASE ARM	
26	062681212	1	ナベコ437-40X12	SCREW, PAN M4.37-40X12	
27	S12874001	1	チユウカンイトミチ	THREAD GUIDE	
28	060680712	1	バインド437-40X7	SCREW, BIND M4.37-40X7	
29	143602001	1	ミヅツキピン	DOWEL PIN	
30	S12875101	1	ハリイトヘンシンリンクミ	THREAD TAKE-UP ECCENTRIC WHEEL ASSY	
30-1	S12876001	1	イトクリヘンシンリンクミ	TAKE-UP ECCENTRIC WHEEL WITH SCREW	
30-1-1	014770622	2	アナトメネジ6.35クボミ	SET SCREW, SOCKET (CP) M6.35	
30-2	S08973101	1	ハリイトクリロッドクミ	NEEDLE THREAD TAKE-UP ROD ASSY	
30-2-1	018401422	2	アナボルト4X14	BOLT, SOCKET M4X14	
31	018771432	1	アナボルト635-40X14	BOLT, SOCKET M6.35-40X14	
32	155220000	1	ホジヨアツメタルR	AUTO PRESSER ARM BUSH (R)	
33	S08770000	1	ジクメタル	SHAFT BUSH	
34	S08976001	1	ハリイトクリジク	NEEDLE THREAD TAKE-UP SHAFT	
35	S00356001	1	ザガネ	WASHER	
37	S00383001	1	ボルト5.56X8	BOLT, M5.56X8	
38	155539000	1	ダストシール	DUST SEAL	
39	S12878001	1	ハリイトクリレバー	NEEDLE THREAD TAKE-UP LEVER	
40	018771432	1	アナボルト635-40X14	BOLT, SOCKET M6.35-40X14	
41	155162001	1	スパーサ	SPACER	
42	S12879001	1	ハリイトクリ	NEEDLE THREAD TAKE-UP	
43	060680712	2	バインド437-40X7	SCREW, BIND M4.37-40X7	
44	S08981001	1	ハリボウテンピン	NEEDLE BAR TAKE-UP	
45	062670612	1	ナベコ357-40X6	SCREW, PAN M3.57-40X6	
46	S12880001	1	ハリイトウケ	NEEDLE THREAD GUIDE	
47	014680422	1	アナトメネジ4.37クボミ	SET SCREW, SOCKET (CP) M4.37	
48	S12881001	1	ハリイトミチU	THREAD GUIDE (U)	
49	S08505001	2	シメネジ3.18	SCREW, M3.18	
50	S12882001	2	イトアンナイ	THREAD GUIDE	
51	062680612	1	ナベコ4.37-40X6	SCREW, PAN M4.37-40X6	
52	101671002	1	シメネジ4.37	SCREW, M4.37	
53	S12883001	1	テンピンイトミチ	THREAD TAKE-UP THREAD GUIDE	
54	060670612	1	バインド357-40X6	SCREW, BIND M3.57-40X6	
55	S12884001	1	シタイトシチL	LOWER THREAD GUIDE (L)	
56	060660512	2	バインド318-40X5	SCREW, BIND M3.18-40X5	
57	S14198001	1	ヘンシンリンクミ	ECCENTRIC WHEEL WITH SCREW	
57-1	014680622	2	アナトメネジ4.37クボミ	SET SCREW, SOCKET (CP) M4.37	
59	S12886000	1	テンピンロッド	THREAD TAKE-UP ROD	
60	S12887001	1	サークリップ	CLIP	
61	148271001	1	ハリボウリンクジク	NEEDLE BAR LINK STUD	
62	S12888001	1	テンピンウデ	THREAD TAKE-UP ARM	
63	148294001	1	アナトメネジ3.57クボミ	SET SCREW, SOCKET (CP) M3.57	
64	147691000	1	フェルト	FELT	
65	S12889001	1	シタイトテンピン	LOWER THREAD TAKE-UP	
66	S12890001	1	ヘンシンリンクカバー	ECCENTRIC WHEEL COVER	
67	117516001	2	ボルト4.37	BOLT, M4.37	
68	113431002	2	ザガネ	WASHER	

J. リテーナ関係 / Retainer mechanism / Haltevorrichtung /
Mécanisme de retenue / Mecanismo del retenedor

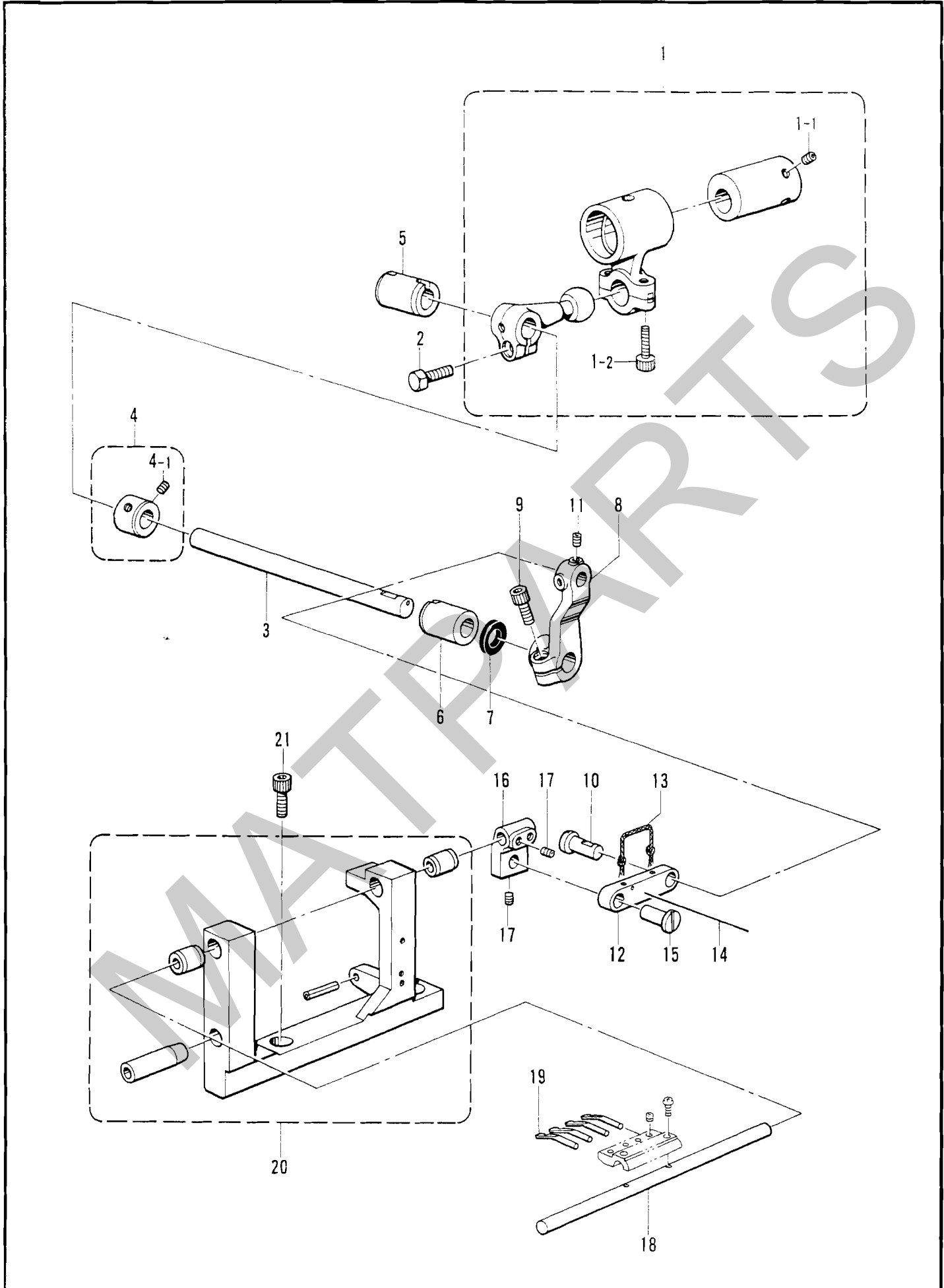

118-281-421

J. リテーナ関係 / Retainer mechanism / Haltevorrichtung /
 Mécanisme de retenue / Mecanismo del retenedor

REF.NO.	CODE	Q'TY	品名	NAME OF PARTS	RM
1	S12851101	1	リテーナヘンシンリンクミ	RETAINER ECCENTRIC WHEEL ASSY	
1-1	153675001	2	アナトメネジ4.37	SET SCREW, SOCKET M4.37	
1-2	018401422	2	アナボルト4X14	BOLT, SOCKET M4X14	
2	017771612	1	ボルト6.35X16	BOLT, M6.35X16	
3	S08927001	1	スプレダジク	SPREADER SHAFT	
4	159441001	2	セツトカラークミ	SET COLLAR ASSY	
4-1	152718001	2	アナトメネジ5.95	SET SCREW, SOCKET M5.95	
5	S12857000	1	リテーナジクメタルB	RETAINER SHAFT BUSH (B)	
6	S12858000	1	リテーナジクメタルF	RETAINER SHAFT BUSH (F)	
7	S12741000	1	ダストシール	DUST SEAL	
8	S12859001	1	リテーナウデ	RETAINER ARM	
9	018061622	1	アナボルト6X16	BOLT, SOCKET M6X16	
10	S12860001	1	ピン	PIN	
11	014680422	2	アナトメネジ4.37クボミ	SET SCREW, SOCKET (CP) M4.37	
12	148403001	1	オクリリンク	FEED LINK	
13	S12861000	1	クミヒモ (L = 130)	WICK (L = 130)	
14	S12862000	1	ハリガネ	WIRE	
15	S12860001	1	ピン	PIN	
16	S12863001	1	リテーナホルダジクダキ	RETAINER HOLDER SHAFT CLAMP	
17	014680422	4	アナトメネジ4.37クボミ	SET SCREW, SOCKET (CP) M4.37	
18	S12864001	1	リテーナホルダジク	RETAINER HOLDER SHAFT	
19	S12865001	4	リテーナ	RETAINER	
20	S12866001	1	リテーナドダイクミ	RETAINER BASE ASSY	
21	018062022	2	アナボルト6X20	BOLT, SOCKET M6X20	

K. プーラ装置関係 / Puller device mechanism / Ziehvorrichtung /
 Mécanisme due puller / Mecanismo del dispositivo de arrastre

020
 040
 041
 050
 051
 060

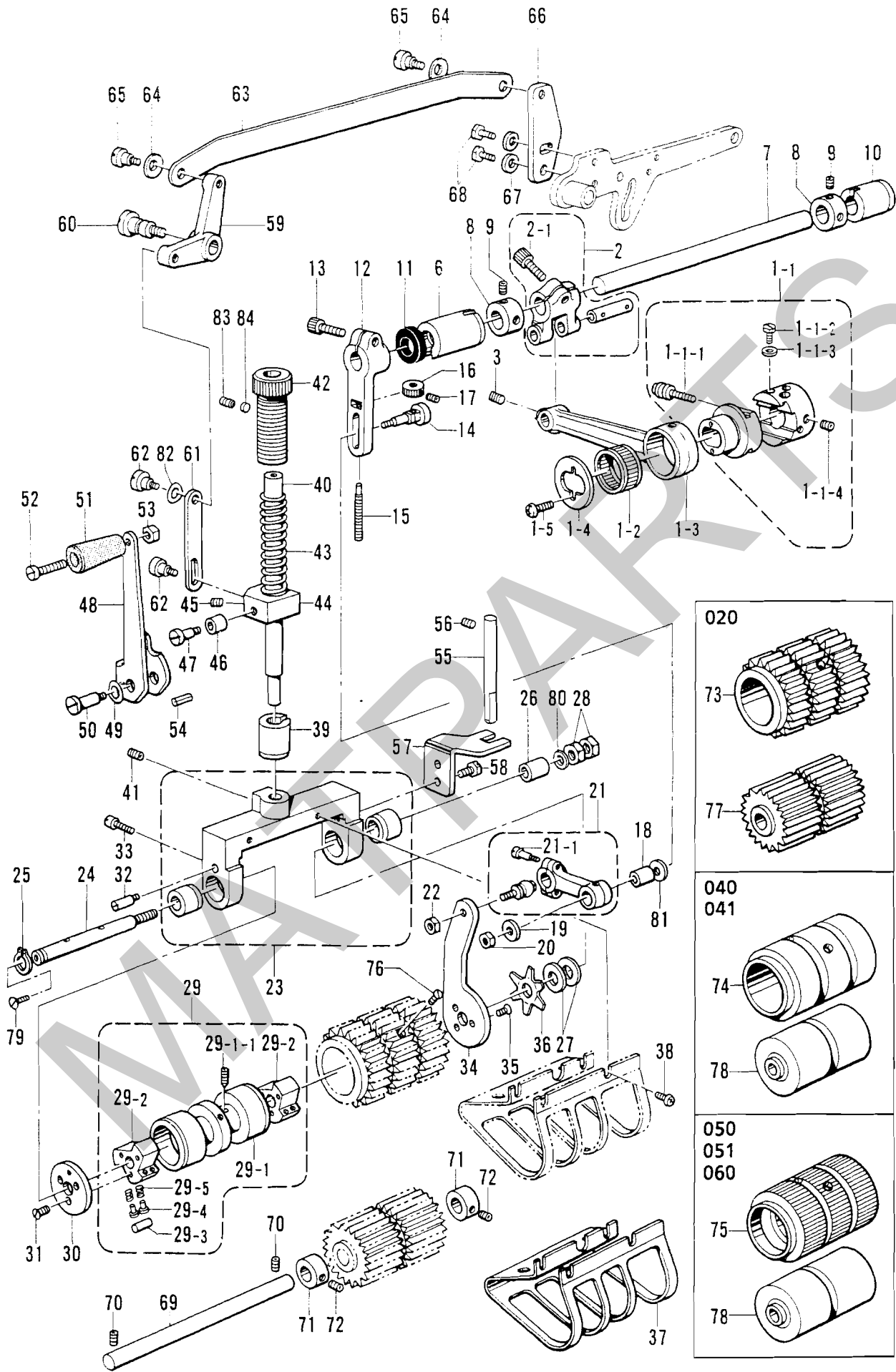

020	
73	
040	
041	
050	
051	
060	

K. プーラ装置関係 / Puller device mechanism / Ziehvorrichtung /
 Mécanisme due puller / Mecanismo del dispositivo de arrastre

REF.NO.	CODE	Q'TY	ヒンメイ	NAME OF PARTS	R
1	S13414201	1	プーラヘンシンリンロツトクミ	PULLER ECCENTRIC WHEEL ROD ASSY	
1-1	S12913-201	1	プーラヘンシンリンクミ	PULLER ECCENTRIC WHEEL ASSY	
1-1-1	113644001	1	ヘンシンリンチヨウセツネジ	ADJUST SCREW	
1-1-2	144075001	2	ボルト3.57	BOLT, M3.57	
1-1-3	105161004	2	ザガネ	WASHER	
1-1-4	014760622	3	アナトメネジ5.95	SET SCREW, SOCKET (CP) M5.95	
1-2	S12915001	1	ニードルジクウケ25	NEEDLE ROLLER BEARING 25	
1-3	S12916001	1	プーラロッド	PULLER ROD	
1-4	S12821001	1	レンカンオサエ	CONNECTING ROD PRESSER	
1-5	062630612	2	ナベコ238-56X6	SCREW, PAN M2.38-56X6	
2	S17773001	1	クランクジクウデピンクミ	CRANK LEVER PIN ASSY	
2-1	018771432	1	アナボルト635-40X14	BOLT, SOCKET M6.35-40X14	
3	014770622	1	アナトメネジ6.35クボミ	SET SCREW, SOCKET (CP) M6.35	
6	148121000	1	クランクジクメタルL	CRANK SHAFT BUSH (L)	
7	S12917001	1	プーラクドウジク	PULLER DRIVING SHAFT	
8	140092001	2	セツトカラー	SET COLLAR	
9	014680422	4	アナトメネジ4.37クボミ	SET SCREW, SOCKET (CP) M4.37	
10	148120000	1	クランクジクメタルR	CRANK SHAFT BUSH (R)	
11	S12918000	1	ダストシール	DUST SEAL	
12	S12919001	1	プーラクドウレバー	PULLER DRIVING LEVER	
13	018061622	1	アナボルト6X16	BOLT, SOCKET M6X16	
14	S12920001	1	プーラレンカンジク	PULLER CONNECTING SHAFT	
15	S12921001	1	チヨウセツネジ	ADJUST SCREW	
16	S12922001	1	ツマミ	KNOB	
17	148294001	1	アナトメネジ3.57クボミ	SET SCREW, SOCKET (CP) M3.57	
18	S12923001	1	レンカンスリーブ	CONNECTING ROD SLEEVE	
19	107453001	1	ザガネ	WASHER	
20	110140001	1	ナツト5.56	NUT, M5.56	
21	S12924001	1	プーラレンカンクミ	PULLER CONNECTING ROD ASSY	
21-1	100526003	2	ダンネジ3.57	STUD SCREW, M3.57	
22	110140001	1	ナツト5.56	NUT, M5.56	
23	S12927001	1	プーラフレームクミ	PULLER FRAME ASSY	
24	S28256001	1	プーラジク	PULLER SHAFT	
25	048090142	1	トメワジクヨウC9	RETAINING RING, C9	
26	S12933001	1	プーラブツシュ	PULLER BUSH	
27	S02556001	2	ザガネ	WASHER	
28	105812003	2	ナツト7.94	NUT, M7.94	
29	S12934101	1	プーラクラツチクミ	PULLER CLUTCH ASSY	
29-1	S13415101	1	プーラクラツチシュウクミ	PULLER CLUTCH SHOE ASSY	
29-1-1	118853001	1	アナトメネジ5.95	SET SCREW, SOCKET M5.95	
29-2	S09039001	2	クラツチツメ	CLUTCH CLAW	
29-3	150604101	6	コロ	ROLLER	
29-4	150605001	12	クラツチピン	CLUTCH PIN	
29-5	S12900001	12	クラツチバネ	SPRING	
30	S12936001	1	クラツチイタ	CLUTCH PLATE	
31	106128004	3	サラネジ3.57	SCREW, FLAT M3.57	
32	S12937101	1	スタツド	STUD	
33	121007001	1	アタマツキトメネジ4.37	SET SCREW, M4.37	
34	S12938001	1	クラツチレバー	CLUTCH LEVER	
35	106128004	3	サラネジ3.57	SCREW, FLAT M3.57	
36	S12939001	1	ホシガタバネ	SPRING	
37	S12940101	1	プーラガード	PULLER GUARD	
38	062670612	4	ナベコ357-40X6	SCREW, PAN M3.57-40X6	
39	154892000	1	ハリボウクランクメタルR	NEEDLE BAR CRANK SHAFT BUSH (R)	
40	S12942001	1	プーラオサエボウ	PULLER PRESSER BAR	
41	014760622	2	アナトメネジ5.95	SET SCREW, SOCKET (CP) M5.95	
42	S12943001	1	プーラアツチヨウセツネジ	ADJUST SCREW	
43	S12944001	1	プーラオサエバネ	SPRING	
44	S12945001	1	プーラオサエボウダキ	PULLER PRESSER BAR CLAMP	

K. プーラ装置関係 / Puller device mechanism / Ziehvorrichtung /
 Mécanisme due puller / Mecanismo del dispositivo de arrastre

020
 040
 041
 050
 051
 060

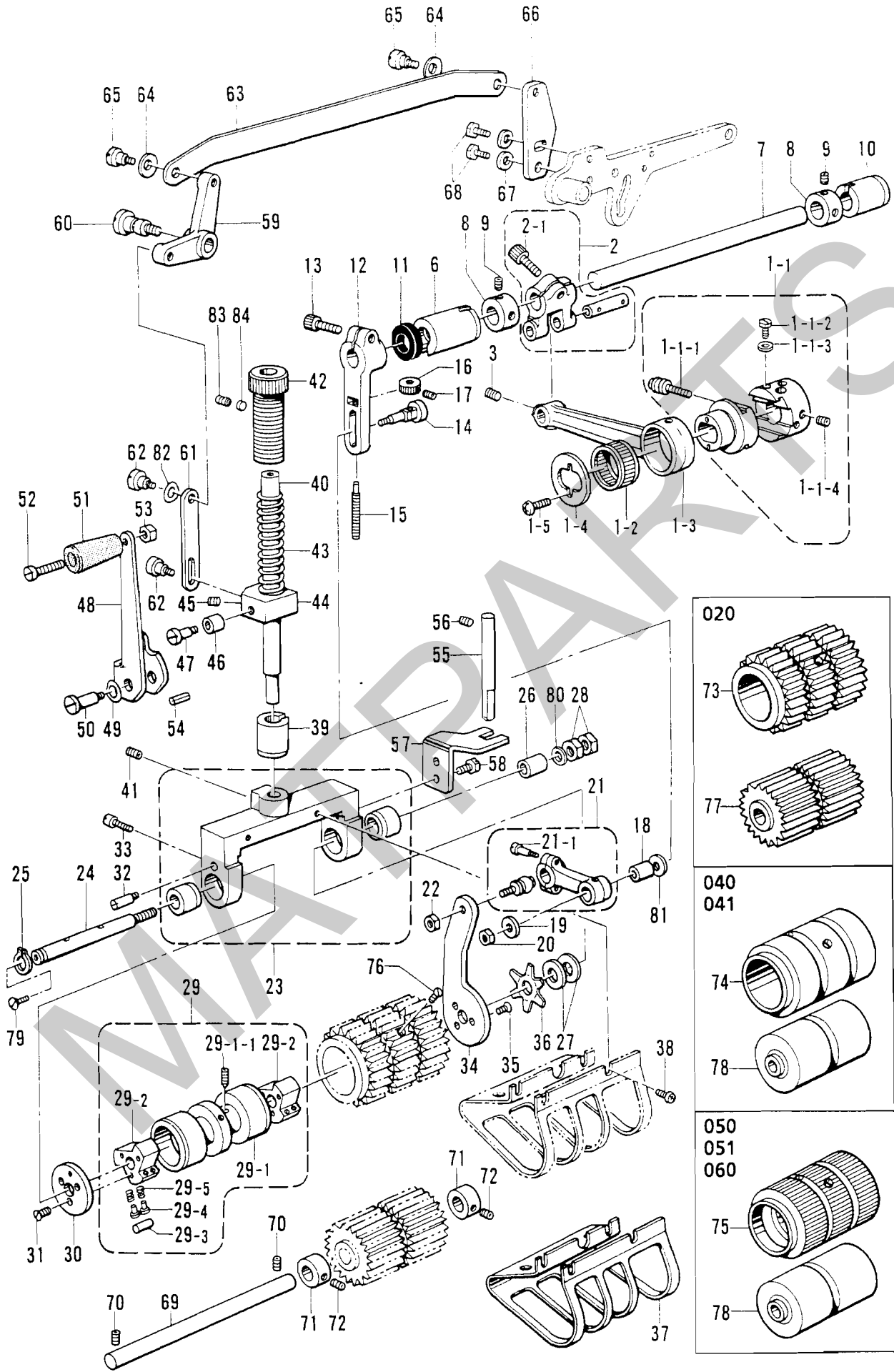

020	
73	
77	
040	
041	
74	
78	
050	
051	
060	
75	
78	

K. プーラ装置関係 / Puller device mechanism / Ziehvorrichtung /
Mécanisme due puller / Mecanismo del dispositivo de arrastre

REF.NO.	CODE	Q'TY	ヒンメイ	NAME OF PARTS	RM
45	014770622	1	アナトメネジ6.35クボミ	SET SCREW, SOCKET (CP) M6.35	
46	110167001	1	コロ	ROLLER	
47	110168001	1	コロジク	ROLLER SHAFT	
48	S12946001	1	プーラアゲレバー	PULLER LIFTING LEVER	
49	109239001	1	ナミバネザガネ	WAVE SPRING WASHER	
50	S28333001	1	ダンネジ5.95	STUD SCREW, M5.95	
51	159093009	1	ハンドル	HANDLE	
52	112700001	1	シメネジ5.95	SCREW, M5.95	
53	106588003	1	ナツト5.95	NUT, M5.95	
54	047400842	1	スプリングピンAW4X8	PIN, SPRING ROLL AW4	
55	S14172001	1	プーラアンナイボウ	PULLER GUIDE BAR	
56	014680622	1	アナトメネジ4.37クボミ	SET SCREW, SOCKET (CP) M4.37	
57	S12948001	1	プーラアンナイイタ	PULLER GUIDE PLATE	
58	117516001	2	ボルト4.37	BOLT, M4.37	
59	S12949001	1	プーラアゲテコ	PULLER LIFTER LEVER	
60	S28268001	1	ダンネジ7.94	STUD SCREW, M7.94	
61	S12950001	1	プーラアゲイタ	PULLER LIFTER PLATE	
62	S08777001	2	ダンネジ4.37	STUD SCREW, M4.37	
63	S12951001	1	プーラレンケツイタ	PULLER CONNECTING PLATE	
64	107017002	2	ナミバネザガネ	WAVE SPRING WASHER	
65	S08777001	2	ダンネジ4.37	STUD SCREW, M4.37	
66	S12952001	1	チヨウセツイタ	ADJUST PLATE	
67	148847001	2	ザガネ	WASHER	
68	017681012	2	ボルト4.37X10	BOLT, M4.37X10	
69	S12953001	1	シタローラジク	LOWER ROLLER SHAFT	
70	014680422	2	アナトメネジ4.37クボミ	SET SCREW, SOCKET (CP) M4.37	
71	S12954001	2	セツトカラー	SET COLLAR	
72	014680422	4	アナトメネジ4.37クボミ	SET SCREW, SOCKET (CP) M4.37	
76	102538002	3	サラネジ3.57	SCREW, FLAT M3.57	
79	107272002	1	サラネジ4.37	SCREW, FLAT M4.37	
80	107153001	1	ザガネ	WASHER	
81	156265001	1	ザガネ	WASHER	
82	103810002	1	ナミガタバネザガネ	WAVE SPRING WASHER	
83	014680422	1	アナトメネジ4.37クボミ	SET SCREW, SOCKET (CP) M4.37	
84	S11624000	1	トメネジアテ	SET SCREW PLATE	
<020><ゴム付け用/ FOR ELASTIC GATHERED WAISTBANDS>					
73	S28875000	1	プラスチックギヤU28	PLASTIC GEAR (U28)	
77	S28876000	1	プラスチックギヤD23	PLASTIC GEAR (D23)	
<040,041><前立縫い用/ FOR SHIRTFRONTS>					
74	S12956001	1	ゴムローラU	RUBBER ROLLER (U)	
78	S12959000	1	ゴムローラ-Dクミ	RUBBER ROLLER (D) ASSY	
<050,051,060><腰裏付け用/ FOR WAISTBANDS OF JEANS>					
75	S12957001	1	スチールギヤU60	STEAL GEAR (U60)	
78	S12959000	1	ゴムローラ-Dクミ	RUBBER ROLLER (D) ASSY	
<020><オプションパーツ/ OPTION PARTS>					
73	S12955000	1	プラスチックギヤU22	PLASTIC GEAR (U22)	
77	S12958000	1	プラスチックギヤD18	PLASTIC GEAR (D18)	

020

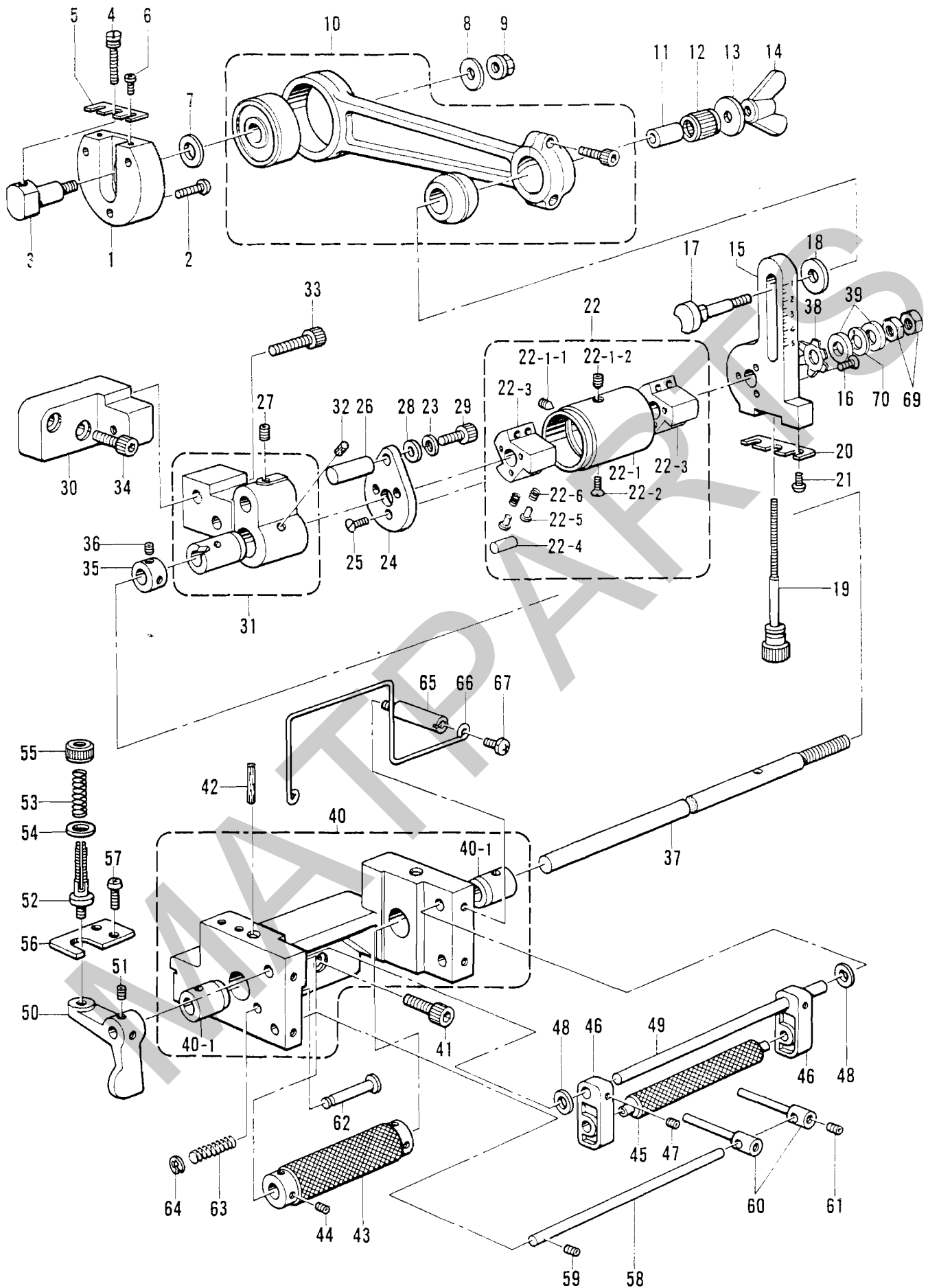

L. 下ゴム送り関係 / Lower rubber feed mechanism / Untere gummibandzuführungvorrichtung / Mécanisme d'entraînement / Mecanismo de alimentación

REF.NO.	CODE	Q'TY	品名	NAME OF PARTS	RM
1	S09023101	1	ヘンシンドタイ	ECCENTRIC WHEEL BASE	
2	062681412	3	ナベコ437-40X14	SCREW, PAN M4.37-40X14	
3	S09024001	1	ヘンシンチヨウセツジク	ECCENTRIC WHEEL ADJUST SHAFT	
4	S09025001	1	ヘンシンチヨウセツネジ	ADJUST SCREW	
5	S09026001	1	ヘンシントメータ	ECCENTRIC WHEEL STOPPER PLATE	
6	062670612	2	ナベコ357-40X6	SCREW, PAN M3.57-40X6	
7	S09027001	1	ヒラザガネシヨウ10	WASHER, PLAIN S 10	
8	107453001	1	ザガネ	WASHER	
9	110778002	1	ザツキナツト5.56	NUT, WASHER M5.56	
10	S12896101	1	シタゴムオクリロツドクミ	LOWER FEED ROD ASSY	
11	S09036001	1	ゴムオクリブシユ	RUBBER FEED BUSH	
12	S09032001	1	ニードルジクウケ	NEEDLE BEARING	
13	116662004	1	ザガネ	WASHER	
14	148007001	1	チヨウナツト4.76	NUT, M4.76	
15	S09033001	1	ゴムオクリレバー	RUBBER FEED LEVER	
16	106128004	3	サラネジ3.57	SCREW, FLAT M3.57	
17	S09034001	1	ゴムオクリロツドジク	RUBBER FEED ROD SHAFT	
18	151090001	1	スラストザガネ	THRUST WASHER	
19	S09035001	1	チヨウセツネジ	ADJUST SCREW	
20	S09026001	1	ヘンシントメータ	ECCENTRIC WHEEL STOPPER PLATE	
21	062670612	2	ナベコ357-40X6	SCREW, PAN M3.57-40X6	
22	S12898001	1	クラツチクミ	CLUTCH ASSY	
22-1	S18953001	1	クラツチスリーブクミ	CLUTCH SLEEVE ASSY	
22-1-1	014760622	1	アナトメネジ5.95	SET SCREW, SOCKET (CP) M5.95	
22-1-2	118853001	1	アナトメネジ5.95	SET SCREW, SOCKET M5.95	
22-2	102843004	1	サラネジ3.57	SCREW, FLAT M3.57	
22-3	S09039001	2	クラツチツメ	CLUTCH CLAW	
22-4	150604101	6	コロ	ROLLER	
22-5	150605001	12	クラツチピン	CLUTCH PIN	
22-6	S12900001	12	クラツチバネ	SPRING	
23	028060242	1	バネザガネ2-6	WASHER, SPRING 2-6	
24	S09040001	1	クラツチフタ	CLUTCH CAP	
25	106128004	3	サラネジ3.57	SCREW, FLAT M3.57	
26	S09041001	1	ストツブピン	PIN	
27	014780622	1	アナトメネジ6.35クボミ	SET SCREW, SOCKET (CP) M6.35	
28	118735002	1	ザガネ	WASHER	
29	018061422	1	アナボルト6X14	BOLT, SOCKET M6X14	
30	S12704001	1	チヨウセツドタイ	ADJUST BASE	
31	S12822001	1	ゴムオクリロダイクミ	RUBBER FEED BASE (R) ASSY	
32	S09043000	1	フェルト	FELT	
33	018062022	2	アナボルト6X20	BOLT, SOCKET M6X20	
34	018062022	2	アナボルト6X20	BOLT, SOCKET M6X20	
35	110197001	1	セツトカラー	SET COLLAR	
36	153675001	2	アナトメネジ4.37	SET SCREW, SOCKET M4.37	
37	S16258001	1	シタゴムオクリジク	LOWER RUBBER FEED SHAFT	
38	S16257001	1	ホシガタバネS	SPRING (S)	
39	148239001	2	ゼンゴジクカラー	THRUST COLLAR	
40	S12904001	1	ゴムオクリダイLクミ	RUBBER FEED BRACKET (L) ASSY	
40-1	S09049000	2	ゴムオクリメタルL	RUBBER FEED SHAFT BUSH (L)	
41	018061422	2	アナボルト6X14	BOLT, SOCKET M6X14	
42	147691000	2	フェルト	FELT	
43	S12906001	1	ゴムオクリローラ	RUBBER FEED ROLLER	
44	148294001	4	アナトメネジ3.57クボミ	SET SCREW, SOCKET (CP) M3.57	
45	S12907001	1	テンションローラ	TENSION ROLLER	
46	S09052001	2	テンションローラササエ	TENSION ROLLER SUPPORT	
47	014680422	2	アナトメネジ4.37クボミ	SET SCREW, SOCKET (CP) M4.37	
48	109763002	2	ザガネ	WASHER	
49	S12908001	1	テンションローラササエジク	TENSION ROLLER SUPPORT SHAFT	
50	S12941001	1	ローラアゲテコ	ROLLER LIFTING LEVER	
51	014680422	2	アナトメネジ4.37クボミ	SET SCREW, SOCKET (CP) M4.37	
52	110820101	1	イトチヨウシボウ	TENSION STUD	
53	146688001	1	レンカンペンバネ	SPRING	
54	025770232	1	ヒラザガネチユウ6.35	WASHER, PLAIN M 6.35	
55	100136001	1	イトチヨウシナツト	TENSION NUT	
56	S12909001	1	ストツブイタ	STOPPER PLATE	
57	062680812	2	ナベコ437-40X8	SCREW, PAN M4.37-40X8	
58	S12910001	1	ゴムガイドジク	RUBBER GUIDE SHAFT	
59	014680422	2	アナトメネジ4.37クボミ	SET SCREW, SOCKET (CP) M4.37	
60	S12911001	2	ゴムガイド	RUBBER GUIDE	
61	014680422	2	アナトメネジ4.37クボミ	SET SCREW, SOCKET (CP) M4.37	
62	S09058001	1	ローラアゲボウ	ROLLER LITING BAR	
63	S09059001	1	ローラアゲバネ	SPRING	
64	048030342	1	トメワE3	RETAINING RING, E3	
65	148042001	2	ベルトカバースタツド	BELT COVER STUD	
66	S12912001	1	ゴムガイドU	RUBBER GUIDE (U)	
67	060680712	2	バインド437-40X7	SCREW, BIND M4.37-40X7	
69	105812003	2	ナツト7.94	NUT, M7.94	
70	S16466000	1	オイレスワツシヤ	WASHER	

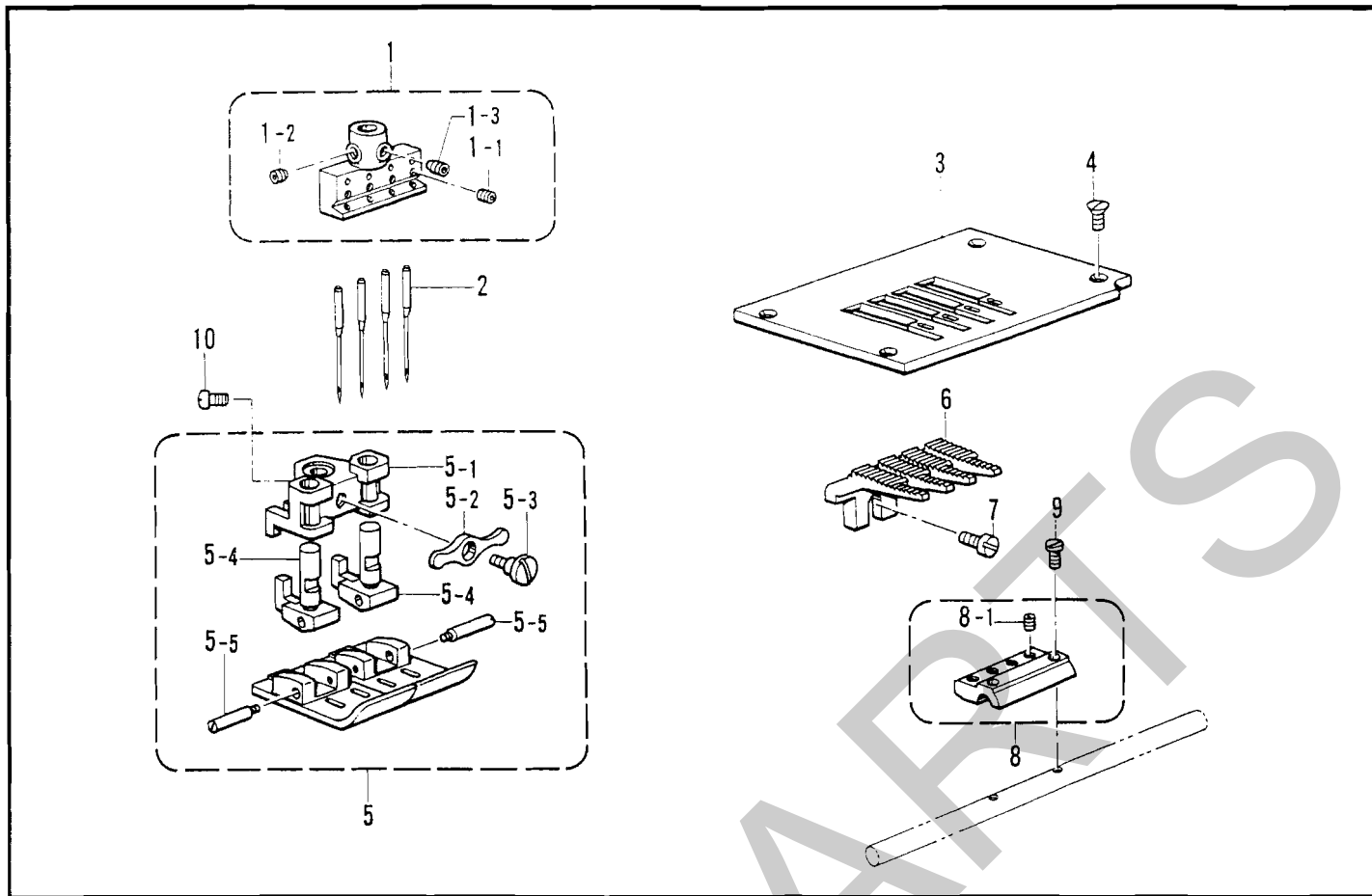

118-281-231

N. ラッパー関係 / Lapper mechanism / Falz-mechanismus / Mécanisme à rabat / Mecanismo de solapado

<オプションパーツ / OPTION PARTS>

050
051
060

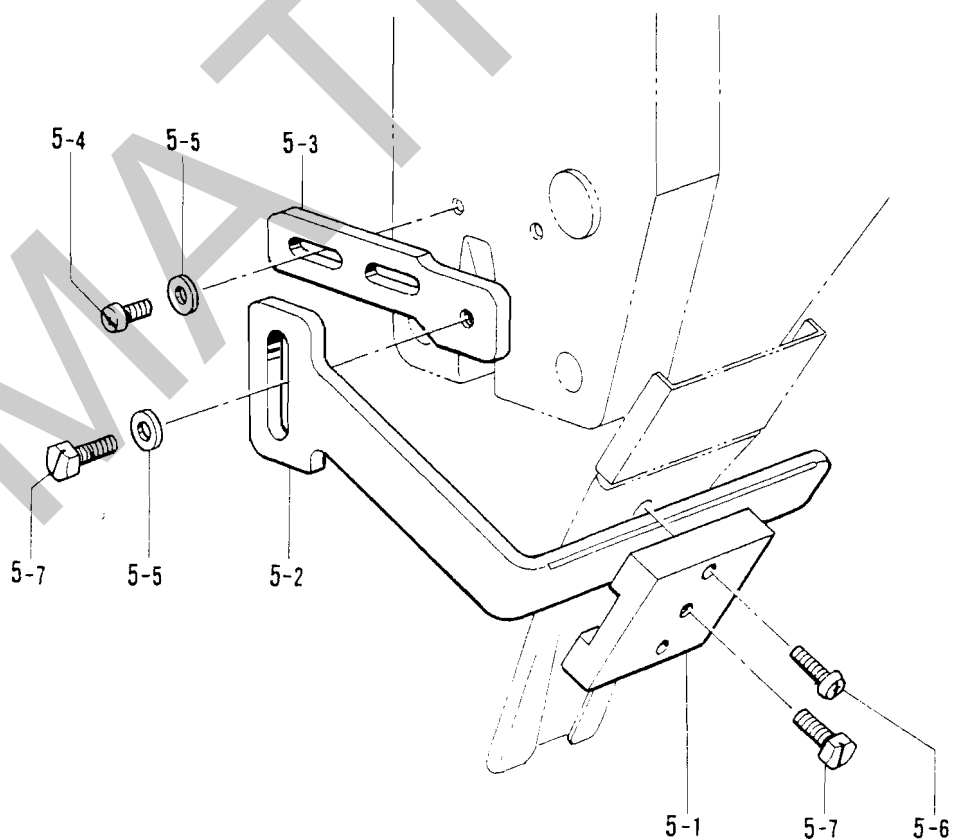

118-281-239

M. ゲージ関係 / Gauge parts / Lehren / Pièces du jauge / Piezas de calibradores

REF.NO.	CODE	Q'TY	ヒンメイ	NAME OF PARTS	RM
1	※	1	ハリドメクミ	NEEDLE CLAMP ASSY	
1-1	146427001	4	アナトメネジ3.18クボミ	SET SCREW, SOCKET (CP) M3.18	
1-2	153675001	1	アナトメネジ4.37	SET SCREW, SOCKET M4.37	
1-3	S12758001	1	アナトガリ4.37	SET SCREW, SOCKET (CN) M4.37	
2	※	4	ミシンハリUY113GS	NEEDLE (UY113GS)	
3	※	1	ハリイタ	NEEDLE PLATE	
4	S09121001	4	マルサラネジ3.57X6	SCREW, FLAT M3.57X6	
5	※	1	オサエクミ	PRESSER FOOT ASSY	
5-1	S12768001	1	オサエシジタイ	PRESSER FOOT BASE	
5-2	S12769001	1	オサエシジイタ	PRESSER FOOT INDICATE PLATE	
5-3	100294002	1	ダンネジ4.76	STUD SCREW 4.76	
5-4	S12770001	2	オサエシジボウ	PRESSER FOOT INDECATATE BAR	
5-5	S12771001	2	オサエピン	PIN	
10	100366002	2	マルヒラトメネジ4.37X5	SET SCREW, (FT) M4.37X5	
6	※	1	オクリバ	FEED DOG	
7	107093002	1	シメネジ4.37	SCREW, M4.37	
8	※	1	リテーナホルダクミ	RETAINER HOLDER ASSY	
8-1	146427001	4	アナトメネジ3.18クボミ	SET SCREW, SOCKET (CP) M3.18	
9	S08505001	2	シメネジ3.18	SCREW, M3.18	

118-281-231

N. ラッパー関係 / Lapper mechanism / Falz-mechanismus /
Mécanisme à rabat / Mecanismo de solapado

REF.NO.	CODE	Q'TY	ヒンメイ	NAME OF PARTS	RM
<オプションパーツ / OPTION PARTS>					
<050,051,060> <上下ウエストラッパー用 / For top and bottom waistband attachment>					
5	S18635001	1	ラツパートリツケイタクミ	LAPPER SET PLATE ASSY	
5-1	S18574001	1	ラツパートリツケイタ	LAPPER SET PLATE	
5-2	S18575001	1	アングルイタ	ANGLE PLATE	
5-3	S18576001	1	アングルドダイ	ANGLE BRACKET	
5-4	062681012	2	ナベコ437-40X10	SCREW, PAN M4.37-40X10	
5-5	146354001	3	ザガネ	WASHER	
5-6	062671212	2	ナベコ357-40X12	SCREW, PAN M3.57-40X12	
5-7	117516001	2	ボルト4.37	BOLT, M4.37	

118-281-239

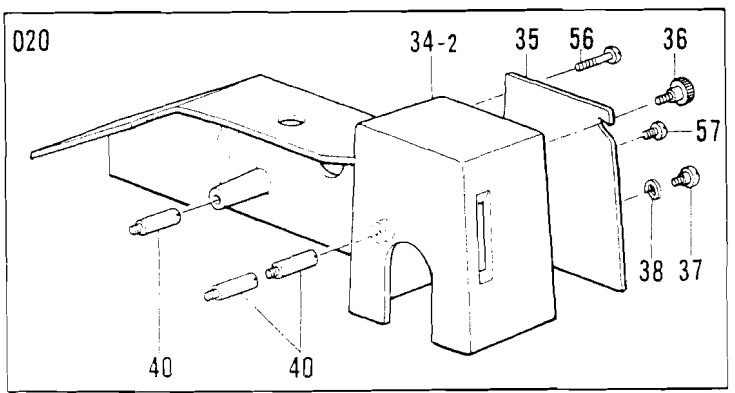
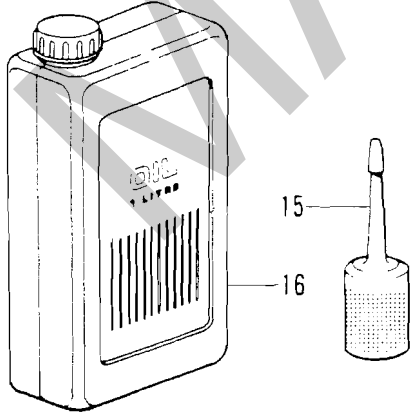
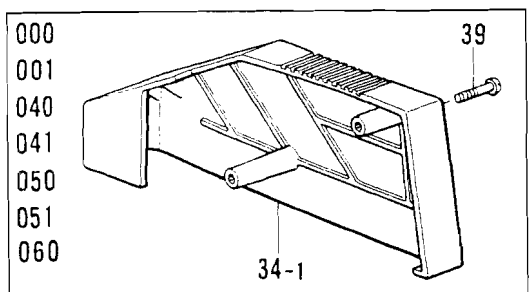
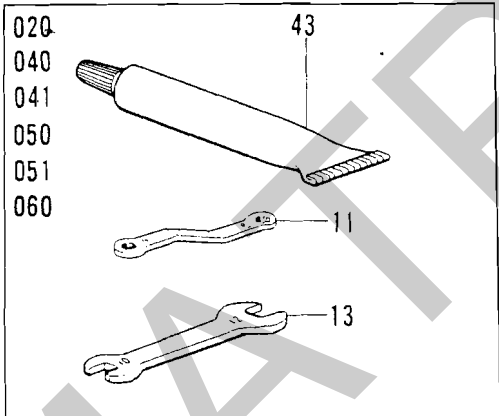
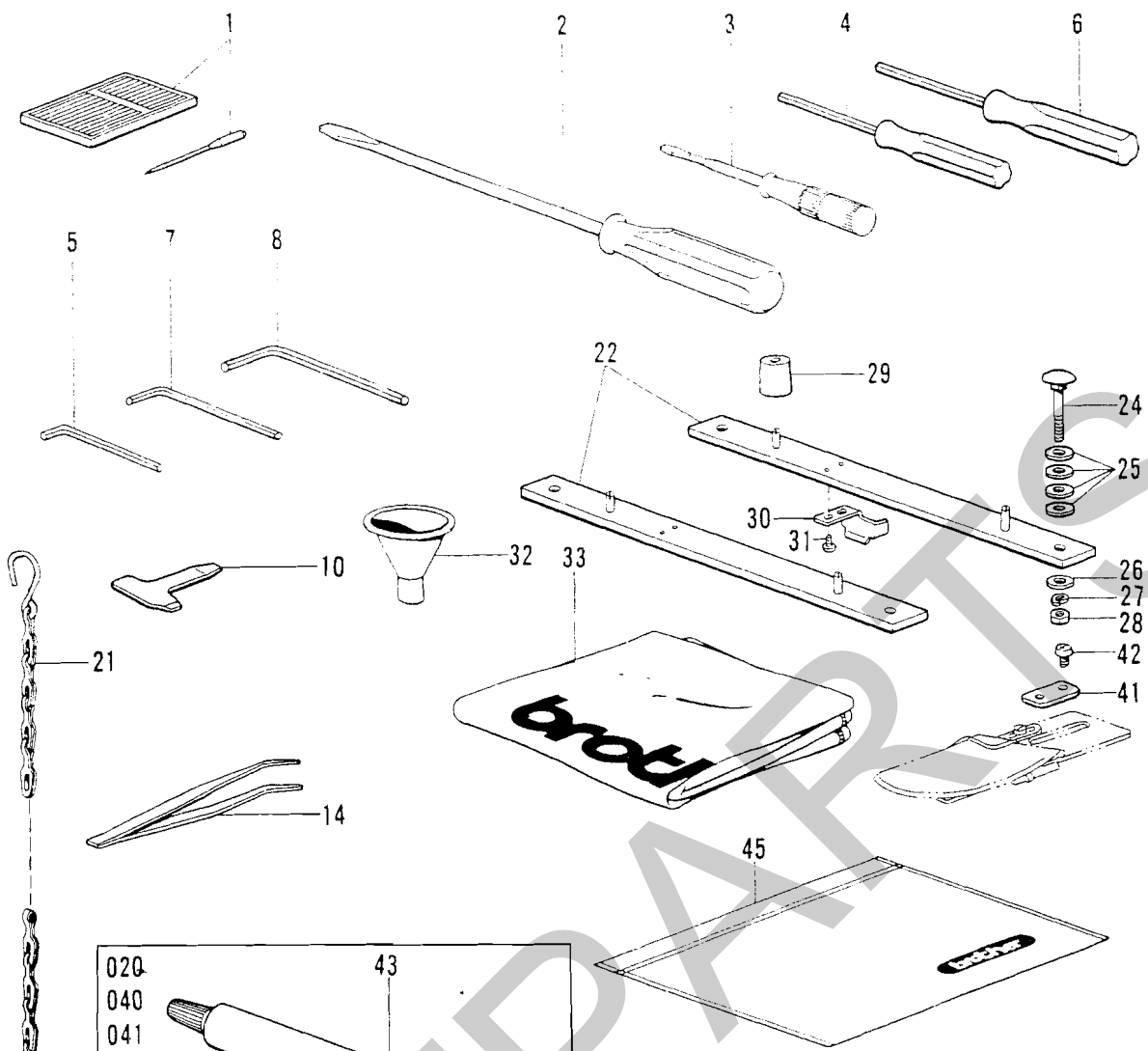

◎ 付属品の明細は変更することがあります。
 ◎ The details of included accessories are subject to change.
 ◎ Änderungen in der Aufstellung der Mitgelieferten Zubehöre sind vorbehalten.
 ◎ Les détails des accessoires inclus sont sujets à des changements.
 ◎ Los detalles de los accesorios incluidos pueden variar.

REF.NO.	CODE	Q'TY	ヒンメイ	NAME OF PARTS	R
1	※	10	ミシンハリUY113GS	NEEDLE (UY113GS)	
2	101572101	1	ネジマワシ5.5X190	SCREW DRIVER 5.5X190	
3	118837001	1	ネジマワシ3.4X70	SCREW DRIVER 3.4X70	
4	S01943001	1	6カクボウネジマワシ1.6	SCREW DRIVER 1.6	
5	146049001	1	6カクボウスパナ2	HEXAGONAL WRENCH 2	
6	S12891001	1	6カクボウネジマワシ2.5	SCREW DRIVER 2.5	
7	142721001	1	6カクボウスパナ3	HEXAGONAL WRENCH 3	
8	150335001	1	6カクボウスパナ5	HEXAGONAL WRENCH 5	
10	138201001	1	チヨウネジマワシ	SCREW DRIVER	
14	117466000	1	ピンセット	PINCETTE	
15	S06701000	1	ポリオイラークミ	POLY OILER ASSY	
16	145277105	1	オイルタンク	OIL TANK	
21	149247001	1	クサリクミ	CHAIN ASSY	
22	S25098001	2	トウブウケイタクミ	MACHINE BASE PLATE ASSY	
24	222372001	4	カクネボルト8X70	BOLT, M8X70	
25	213650001	16	ワ2.3X8.5X38ST	WASHER, M2.3X8.5X38ST	
26	025080236	4	ヒラザガネチユウ8	WASHER, PLAIN M 8	
27	028080242	4	バネザガネ2-8	WASHER, SPRING 2-8	
28	021080106	4	ナツト1シユ8	NUT, 1 M8	
29	147919001	4	ボウシンゴム	RUBBER CUSHION	
30	S09001101	1	クサリガイド	CHAIN GUIDE	
31	060680712	2	バインド437-40X7	SCREW, BIND M4.37-40X7	
32	140759000	1	ジョーゴ	FUNNEL	
33	144224001	1	トウブカバー	HEAD COVER	
41	S12894001	1	ラツバザガネ	LAPPER WASHER	
42	060680712	2	バインド437-40X7	SCREW, BIND M4.37-40X7	
45	122991001	1	フゾクヒンポリフクロ	ACCESSORY BAG	
<020,040,041,050,051,060>					
11	105343001	1	メガネレンチ8X9	WRENCH 8X9	
13	107780001	1	スパナ10X12	SPANNER 10X12	
43	S09021000	1	グリス	GREASE	
<000,001,040,041,050,051,060>					
34-1	S09002009	1	ベルトカバー	BELT COVER	
39	102424004	2	シメネジ4.37	SCREW, M4.37	
<020><ゴム付け用/ FOR ELASTIC GATHERED WAISTBANDS>					
34-2	S12893009	1	ベルトカバー	BELT COVER	
35	S13583009	1	ベルトカバーフタ	BELT COVER PLATE	
36	129984002	1	ツマミネジ3.57	SCREW, M3.57	
37	113730001	1	ダンネジ4.37	STUD SCREW, M4.37	
38	146598001	1	バネザガネ	WASHER, SPRING	
40	148042001	3	ベルトカバースタッド	BELT COVER STUD	
56	102023005	1	シメネジ4.37	SCREW 4.37	
57	062681012	1	ナベコ437-40X10	SCREW, PAN M4.37-40X10	

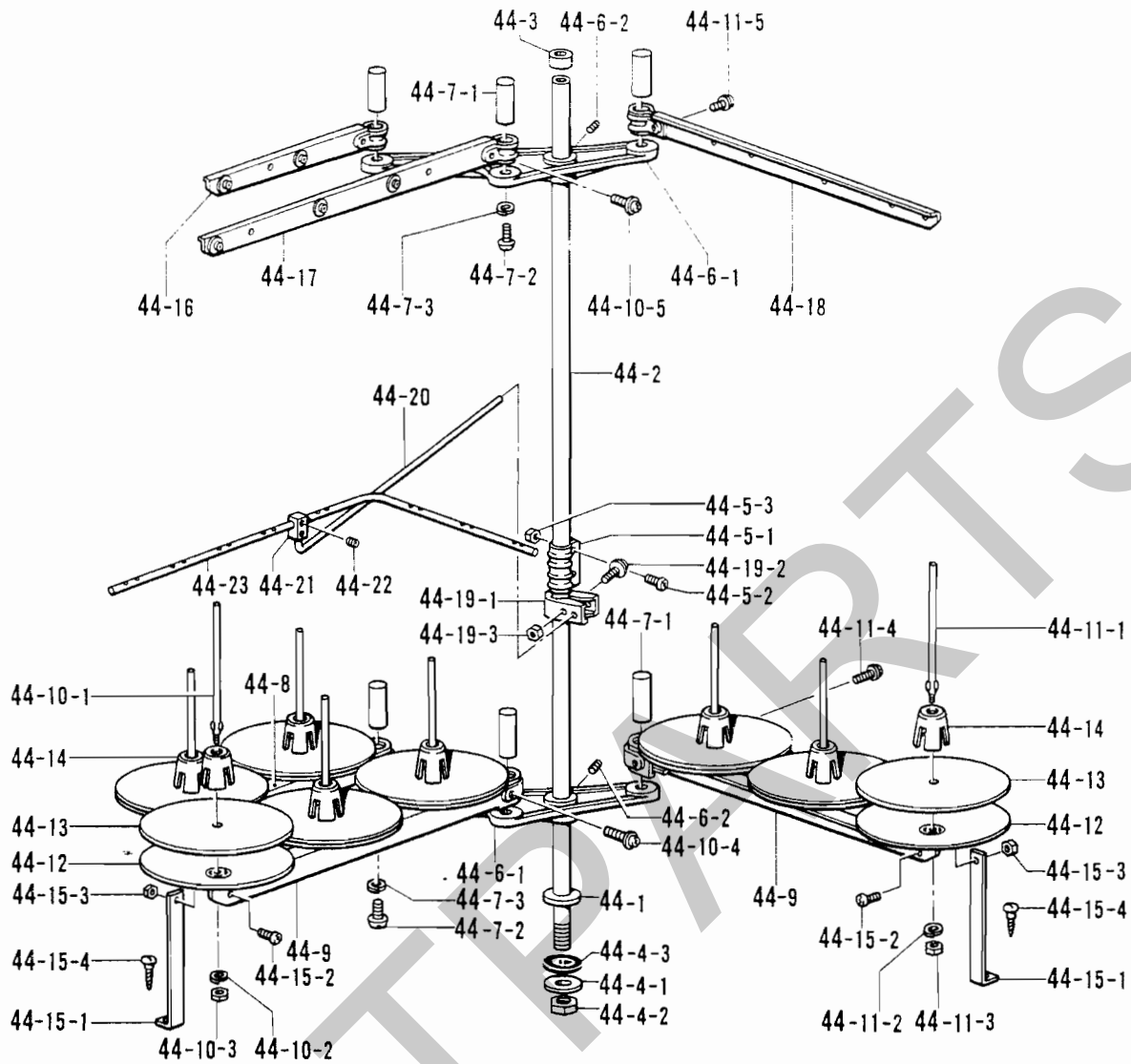



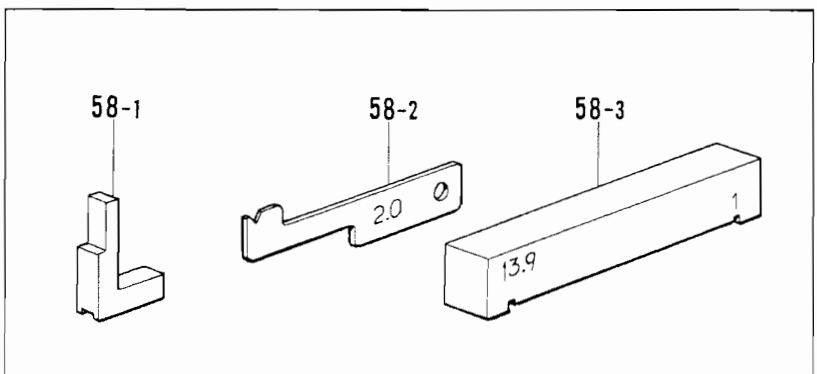
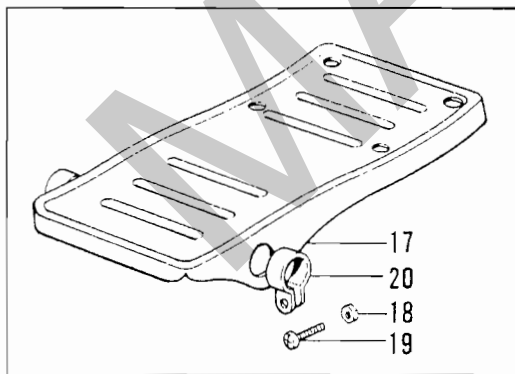







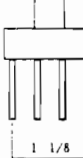



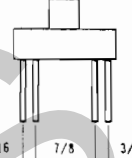
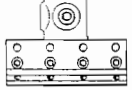
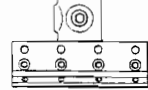
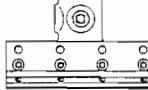

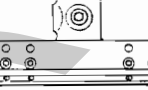
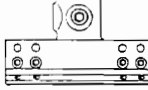
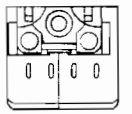
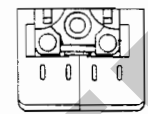
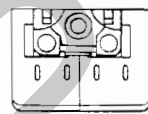
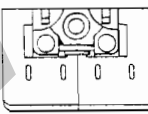
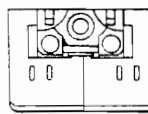
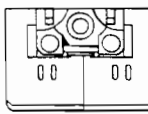
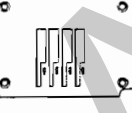
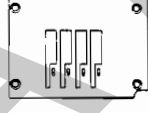
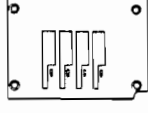
<オプションパーツ / OPTION PARTS>

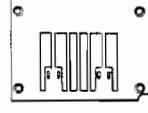
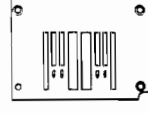

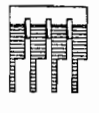

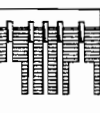
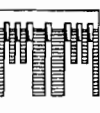



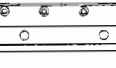
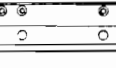
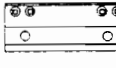

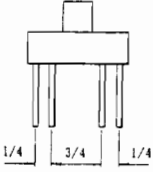
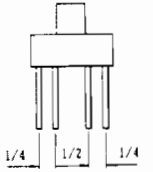
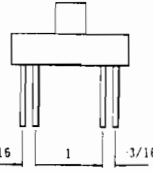
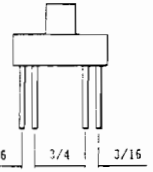
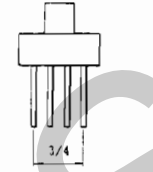
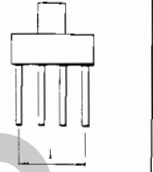
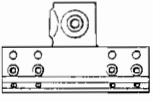
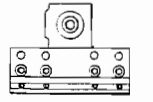
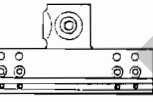
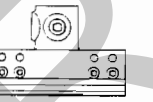
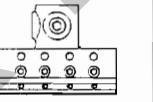
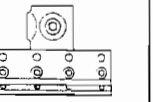
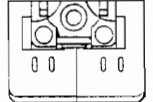
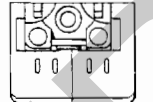
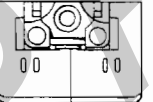
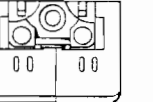
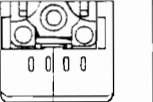
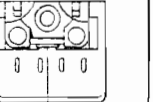

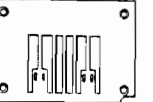
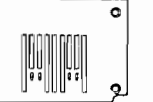

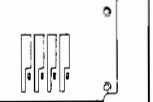
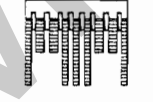
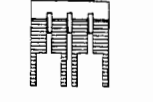

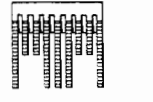
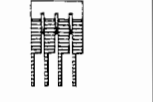
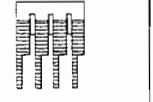

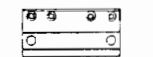
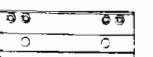
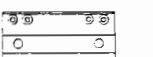
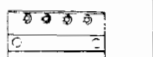



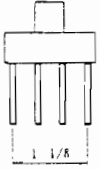
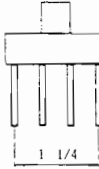
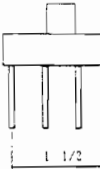



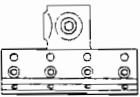
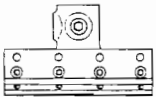
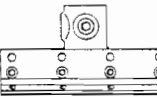
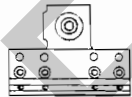
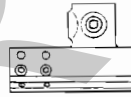
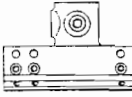
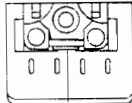
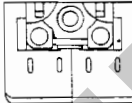
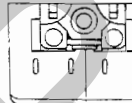
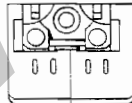
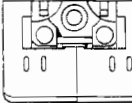
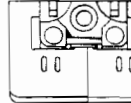

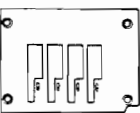
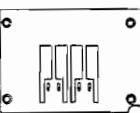
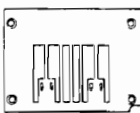

- ◎ 付属品の明細は変更することがあります。
- ◎ The details of included accessories are subject to change.
- ◎ Änderungen in der Aufstellung der Mitgelieferten Zubehöre sind vorbehalten.
- ◎ Les détails des accessoires inclus sont sujets à des changements.
- ◎ Los detalles de los accesorios incluidos pueden variar.





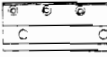



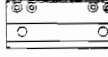

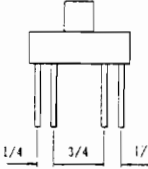
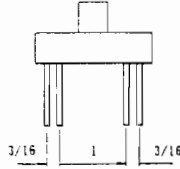
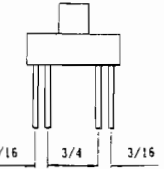

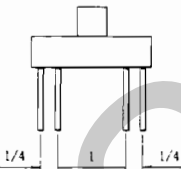
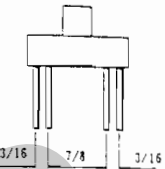
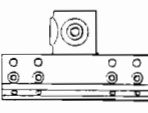
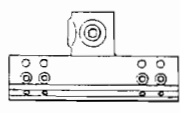
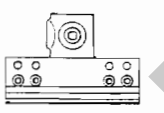
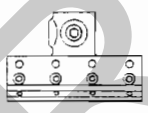
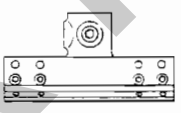
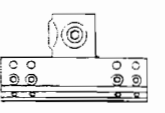
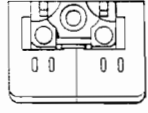
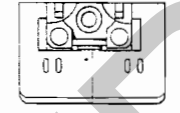
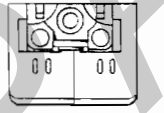
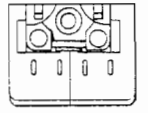
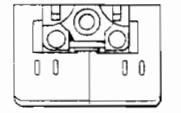
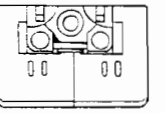
Z2. 付属品関係 / Accessories / Zubehör / Accessoires / Accesorios

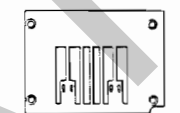
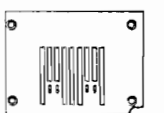

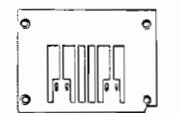
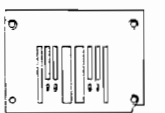
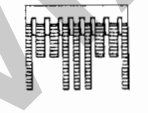
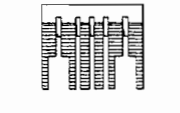
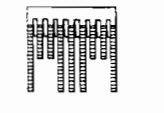
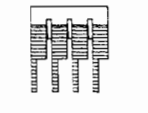
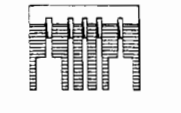
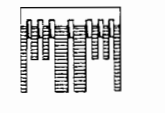

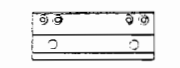
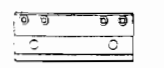





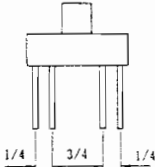
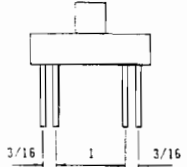
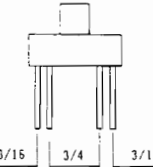
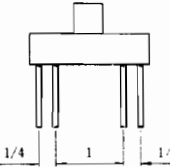

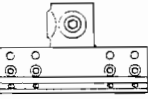
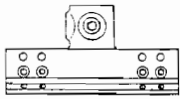
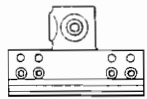
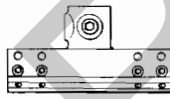

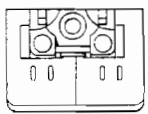
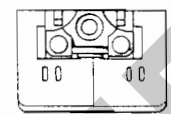
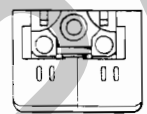
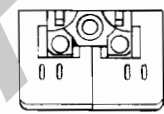
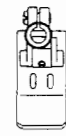
REF.NO.	CODE	Q'TY	ヒンメイ	NAME OF PARTS	RM
44	S12810009	1	イトタテダイクミ8TH	COTTON STAND ASSY 8TH	
44-1	156112003	1	コラムパイプD	COLUMN PIPE (D)	
44-2	150172003	1	コラムパイプ	COLUMN PIPE	
44-3	150174000	1	コラムキャップ	COLUMN CAP	
44-4	S13794001	1	パイプネジセットA	PIPE SCREW SET (A)	
44-4-1	150206000	1	ヒラザガネ16	WASHER, PLAIN 16	
44-4-2	150191002	1	6カクナツト5/8	NUT, 5/8	
44-4-3	S01005000	1	イトタテゴム	RUBBER WASHER	
44-5	150106003	1	コラムジョイントクミ	COLUMN JOINT ASSY	
44-5-1	150173003	1	コラムジョイント	COLUMN JOINT	
44-5-2	062501406	2	ナベコ5X14	SCREW, PAN M5X14	
44-5-3	021500106	2	1シユナツト5	NUT, 1 M5	
44-6	S13173009	2	ホルダーウケダイクミ	HOLDER SUPPORT BRACKET ASSY	
44-6-1	S13174009	2	ホルダーウケダイ	HOLDER SUPPORT BRACKET	
44-6-2	131007001	2	トメネジ6.35クボミ	SET SCREW, (CP) M6.35	
44-7	S13175001	6	ホルダージクSクミ	HOLDER SHAFT (S) ASSY	
44-7-1	S13176001	6	ホルダージクS	HOLDER SHAFT (S)	
44-7-2	062502002	6	ナベコ5X20	SCREW, PAN M5X20	
44-7-3	028050242	6	バネザガネ2-5	WASHER, SPRING 2-5	
44-8	S02778002	1	スプールホルダー2	SPOOL HOLDER 2	
44-9	S02779009	2	スプールホルダー3	SPOOL HOLDER 3	
44-10	S02780001	1	スプールネジセット2	SPOOL SCREW SET 2	
44-10-1	150179002	2	スプールジクB	SPOOL SHAFT (B)	
44-10-2	028050246	2	バネザガネ2-5	WASHER, SPRING 2-5	
44-10-3	021500106	4	1シユナツト5	NUT, 1 M5	
44-10-4	0A1503006	1	+ナベザクミ5X30A	SCREW, PAN (P WASHER) M5X30A	
44-10-5	0A1501406	1	+ナベザクミ5X14A	SCREW, PAN (P WASHER) M5X14A	
44-11	S02782001	2	スプールネジセット3	SPOOL SCREW SET 3	
44-11-1	150179002	3	スプールジクB	SPOOL SHAFT (B)	
44-11-2	028050246	3	バネザガネ2-5	WASHER, SPRING 2-5	
44-11-3	021500106	5	1シユナツト5	NUT, 1 M5	
44-11-4	0A1503006	1	+ナベザクミ5X30A	SCREW, PAN (P WASHER) M5X30A	
44-11-5	0A1501406	1	+ナベザクミ5X14A	SCREW, PAN (P WASHER) M5X14A	
44-12	150180001	8	ウケザラ	SPOOL STAND BASE	
44-13	150182000	8	スプールマット	SPOOL MAT	
44-14	126863001	8	スプールクツシヨン	SPOOL CUSHION	
44-15	S02784009	2	ホルダーササエAセット	HOLDER SUPPORT (A) SET	
44-15-1	150188009	2	スプールホルダーササエA	SPOOL HOLDER SUPPORT (A)	
44-15-2	062501006	2	ナベコ5X10	SCREW, PAN M5X10	
44-15-3	021500106	2	1シユナツト5	NUT, 1 M5	
44-15-4	031452206	2	マルモク45X22	WOOD SCREW, ROUND M4.5X22	
44-16	S02786002	1	スレツドハンガークミ2	THREAD HANGER ASSY 2	
44-17	S02788009	1	スレツドハンガークミ3	THREAD HANGER ASSY 3	
44-18	S13666009	1	スレツドハンガークミ3-5	THREAD HANGER ASSY 3-5	
44-19	150145009	1	イトアンナイホルダークミ	THREAD GUIDE HOLDER ASSY	
44-19-1	150185009	1	イトアンナイホルダー	THREAD GUIDE HOLDER	
44-19-2	0A1503006	1	+ナベザクミ5X30A	SCREW, PAN (P WASHER) M5X30A	
44-19-3	021500106	1	1シユナツト5	NUT, 1 M5	
44-20	S04109001	1	イトアンナイササエボウ	THREAD GUIDE SUPPORT BAR	
44-21	138843001	1	ササエボウツギテ	JOINT	
44-22	014060632	2	アナトメ6X6クボミ	SET SCREW, SOCKET (CP) M6X6	
44-23	S13172001	1	イトアンナイ8	THREAD GUIDE 8	
<オプションパーツ / OPTION PARTS>					
17	147893009	1	オサエアゲフミイタ	TREADLE PEDAL	
18	021400106	2	ナツト1シユ4	NUT, 1 M4	
19	062401406	2	ナベコ4X14	SCREW, PAN M4X14	
20	116016001	2	ペタルトメ	PEDAL STOPPER	
58	S21331001	1	デアイゲージセット	LOOPER TIMING GAUGE SET	
58-1	S15160001	1	ルーバゲージ	LOOPER GAUGE	
58-2	S21332001	1	デアイゲージイタ	GAUGE PLATE	
58-3	S21333001	1	タカサゲージ	HIGHT GAUGE	

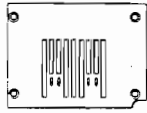
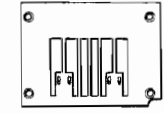
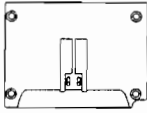
仕様 Specifications	000-2	000-3	000-4	000-5	000-6	000-7
仕様ラベル Label	S12808-040	S12808-041	S12808-042	S12808-043	S12808-044	S12808-045
用途 Application	一般地縫用 (プーラ、下ゴム送り無し) For plain stitching (For w/o puller and lower rubber feed)					
針巾(インチ) Needle Spacing (inch)						
品名 Name of Parts	A	B	C	D	E	F
針止メ組 Needle Clamp Assy						
	S13400-001	S13401-001	S13402-001	S13403-001	S13404-001	S13405-001
押工組 Presser Foot Assy						
	S12767-001	S12774-001	S12777-001	S12780-001	S12783-001	S12786-001
針板 Needle Plate						
	S12760-001	S12761-001	S12762-001	S12763-001	S12764-001	S12765-001
送り歯 Feed Dog						
	S12792-001	S12793-001	S12794-001	S12795-001	S12796-001	S12797-001
リテーナ ホルダ組 Retainer Holder Assy						
	S13407-001	S13408-001	S13409-001	S13410-001	S13411-001	S13412-001
ミシン針 UY113GS Needle UY113GS	S12759-011	←	←	←	←	←

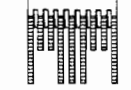
仕様 Specifications	000-8	000-9	001-0	001-1	020-1	020-2
仕様ラベル Label	S12808-046	S12808-047	S12808-048	S12808-049	S12808-006	S12808-007
用途 Application	一般地縫用(プーラ、下ゴム送り無し) For plain stitching (For W/O puller and lower rubber feed)				ゴム付け用 For elastic gathered waistbands	
針巾(インチ) Needle Spacing (inch)						
品名 Name of Parts	G	H	J	K	L	A
針止×組 Needle Clamp Assy	 S13406-001	 S13598-001	 S14261-001	 S14263-001	 S16041-001	 S13400-001
押工組 Presser Foot Assy	 S12789-001	 S13601-001	 S14270-001	 S14273-001	 S16044-001	 S12767-001
針板 Needle Plate	 S12766-001	 S13600-001	 S14267-001	 S14268-001	 S16043-001	 S12760-001
送り歯 Feed Dog	 S12798-001	 S13604-001	 S14279-001	 S14280-001	 S16047-001	 S12792-001
リテーナ ホルダ組 Retainer Holder Assy	 S13413-001	 S13605-001	 S14282-001	 S14284-001	 S16048-001	 S13407-001
ミシン針 UY113GS Needle UY113GS	S12759-011	←	←	←	←	←

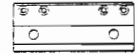
仕様 Specifications	020-3	020-4	020-5	020-9	040-6	040-7
仕様ラベル Label	S12808-008	S12808-009	S12808-010	S12808-033	S12808-011	S12808-012
用途 Application	ゴム付け用 For elastic gathered waistbands				前立縫い用 For shirtfronts	
針巾(インチ) Needle Spacing (inch)						
品名 Name of Parts	B	C	D	H	E	F
針止×組 Needle Clamp Assy						
押工組 Presser Foot Assy						
針板 Needle Plate						
送り歯 Feed Dog						
リテーナ ホルダ組 Retainer Holder Assy						
ミシン針 UY113GS Needle UY113GS	S12759-011	←	←	←	←	←

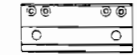
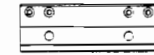
仕様 Specifications	040-8	041-0	041-1	050-3	050-6	050-7
仕様ラベル Label	S12808-013	S12808-014	S12808-015	S12808-023	S12808-016	S12808-017
用途 Application	前立縫い用 For shirtfronts			腰裏付け用 For waistbands of Jeans		
針巾(インチ) Needle Spacing (inch)						
品名 Name of Parts	G	J	K	B	E	F
針止メ組 Needle Clamp Assy						
	S13406-001	S14261-001	S14263-001	S13401-001	S13404-001	S13405-001
押工組 Presser Foot Assy						
	S12789-001	S14270-001	S14273-001	S12774-001	S12783-001	S12786-001
針板 Needle Plate						
	S12766-001	S14267-001	S14268-001	S12761-001	S12764-001	S12765-001
送り歯 Feed Dog						
	S12798-001	S14279-001	S14280-001	S12793-001	S12796-001	S12797-001
リテーナ ホルダ組 Retainer Holder Assy						
	S13413-001	S14282-001	S14284-001	S13408-001	S13411-001	S13412-001
ミシン針 UY113GS Needle UY113GS	S12759-011	←	←	S12759-016	←	←

仕様 Specifications	050-8	051-0	051-1	060-6	オプション Option
仕様ラベル Label	S12808-018	S12808-019	S12808-020	S12808-050	—
用途 Application	腰裏付け用 For waistbands of Jeans			(厚物用) (For thick)	二本針地縫用(厚物用) 2 Needles (For thick)
針巾(インチ) Needle Spacing (inch)					
品名 Name of Parts	G	J	K	E	—
針止メ組 Needle Clamp Assy	 S13406-001	 S14261-001	 S14263-001	 S13404-001	 S28879-001
押工組 Presser Foot Assy	 S12789-001	 S14270-001	 S14273-001	 S28872-001	 S28882-001
針板 Needle Plate	 S12766-001	 S14267-001	 S14268-001	 S28871-001	 S28881-001
送り歯 Feed Dog	 S12798-001	 S14279-001	 S14280-001	 S12796-001	 S28884-001
リテーナ ホルダ組 Retainer Holder Assy	 S13413-001	 S14282-001	 S14284-001	 S13411-001	 S16048-001
ミシン針 UY113GS Needle UY113GS	S12759-016	←	←	S12759-022	S12759-019

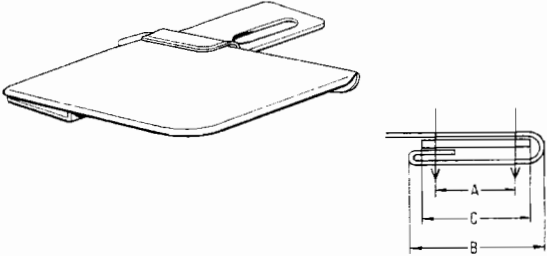
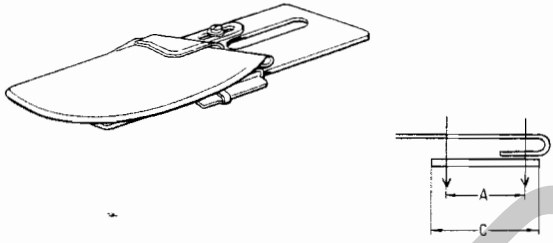
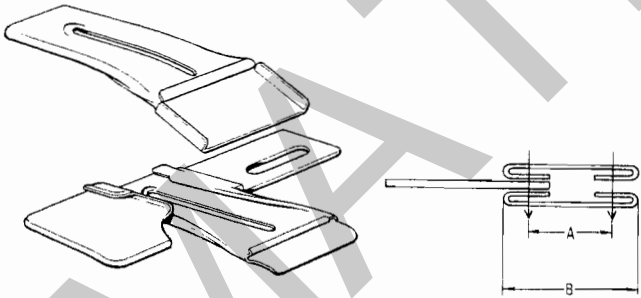
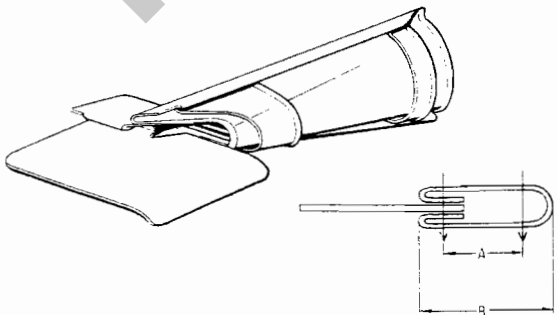
	針幅 (mm) Needle spacing (mm)	仕上り幅 (mm) Finished size (mm)	テープ幅 (mm) Tape size (mm)	部品コード Parts No.
	A	B	C	
簡易三ツ巻平ゴム入 (下巻) Elastic hemmer (Down turn) 	28.5	33	31	S15691-001
	25.4	30	28	S15691-002
	38.1	42	40	S15691-003
	19.1	25	23	S15691-004
	31.8	36	34	S15691-005
平ゴム入バインダー Elastic hemmer (Open elastic) 	-	-	ゴムテープ 幅最大 Elastic max size 40	S15692-001
上下ウエストバンド用ラッパー Top and bottom waistband attachment 	38.1	42	65	S15693-001
	31.8	35	56	S15693-002
カノコ式ウエストバンド用ラッパー Right angle elbow binder 	38.1	42	110	S15694-001
	31.8	35	95	S15694-002
	25.4	30	85	S15694-003

索引/INDEX/VERZEICHIS/
INDEX/INDICE

CODE	REF.NO.	Page
S00313009	A - 22	2
S00356001	H - 35	16
S00383001	H - 37	16
S00879001	C - 22	6
S01005000	Z2 - 44-4-3	30
S01943001	Z1 - 4	28
S02556001	K - 27	20
S02606000	A - 5	2
S02778002	Z2 - 44-8	30
S02779009	Z2 - 44-9	30
S02780001	Z2 - 44-10	30
S02782001	Z2 - 44-11	30
S02784009	Z2 - 44-15	30
S02786002	Z2 - 44-16	30
S02788009	Z2 - 44-17	30
S04109001	Z2 - 44-20	30
S06701000	Z1 - 15	28
S07468000	E - 15	10
S07959001	H - 25	8
S08505001	D - 49	16
	M - 9	26
S08628000	A - 3	2
S08631000	A - 15	2
S08632009	A - 19	2
S08639000	A - 33	2
S08674000	A - 56	2
S08675000	A - 57	2
S08682001	B - 3	4
S08683000	B - 4	4
S08684101	B - 6	4
S08685001	B - 6-1	4
S08686101	B - 6-2	4
S08688001	B - 9	4
S08692101	B - 17	4
S08693001	B - 17-1	4
S08694001	B - 17-2	4
S08696000	B - 25	4
S08767001	C - 1	6
S08768001	C - 2	6
S08769001	C - 6	6
S08770000	C - 12	6
	H - 33	16
S08771001	C - 14	6
S08774001	C - 15	6
S08775000	C - 27	6
S08776001	C - 25	6
S08777001	C - 26	6
	K - 62	22
	K - 65	22
S08871001	D - 10	8
S08889101	E - 1	10
S08890001	E - 1-1	10
S08892001	E - 8	10
S08896101	E - 11	10
S08897001	E - 11-1	10
S08927001	J - 3	18
S08935001	G - 1	14
S08936201	G - 3	14
S08937101	G - 3-4	14
S08939100	G - 3-6	14
S08940000	G - 6	14
S08943000	G - 13	14
S08944001	G - 14	14

CODE	REF.NO.	Page
S08945001	G - 17	14
S08946000	G - 19	14
S08956000	G - 32	14
S08957001	G - 33	14
S08961101	H - 1	16
S08963001	H - 7	16
S08964001	H - 8	16
S08966001	H - 22	16
S08967001	H - 23	16
S08968001	H - 25	16
S08973101	H - 30-2	16
S08976001	H - 34	16
S08981001	H - 44	16
S09001101	Z1 - 30	28
S09002009	Z1 - 34-1	28
S09021000	Z1 - 43	28
S09023101	L - 1	24
S09024001	L - 3	24
S09025001	L - 4	24
S09026001	L - 5	24
	L - 20	24
S09027001	L - 7	24
S09032001	L - 12	24
S09033001	L - 15	24
S09034001	L - 17	24
S09035001	L - 19	24
S09036001	L - 11	24
S09039001	K - 29-2	20
	L - 22-3	24
S09040001	L - 24	24
S09041001	L - 26	24
S09043000	L - 32	24
S09049000	L - 40-1	24
S09052001	L - 46	24
S09058001	L - 62	24
S09059001	L - 63	24
S09120001	B - 17-3	4
S09121001	M - 4	26
S09125001	G - 37	14
S09260001	D - 27	8
S11624000	K - 84	22
S12703001	A - 2	2
S12704001	L - 30	24
S12705009	A - 24	2
S12706000	A - 25	2
S12707001	A - 30-1	2
S12708001	A - 34	2
S12709000	A - 36	2
S12710001	A - 37	2
S12711101	A - 41	2
S12712001	A - 44	2
S12713000	A - 45	2
S12714001	A - 47	2
S12715000	A - 48	2
S12716009	A - 50	2
S12717009	A - 52	2
S12718000	G - 43	14
S12720001	B - 32	4
S12721009	B - 1	4
S12722009	B - 1-1	4
S12724001	B - 8	4
S12725101	B - 11	4
S12729001	B - 27	4

CODE	REF.NO.	Page
S12730001	B - 28	4
S12731001	B - 30	4
S12732201	D - 1	8
S12733001	D - 1-9	8
S12735001	D - 1-13	8
S12736001	D - 6	8
S12737001	D - 8	8
S12738001	D - 13	8
S12740001	D - 19	8
S12741000	D - 22	8
	F - 8	12
	J - 7	18
S12742001	D - 24	8
S12743001	D - 31-3	8
S12758001	M - 1-3	26
S12768001	M - 5-1	26
S12769001	M - 5-2	26
S12770001	M - 5-4	26
S12771001	M - 5-5	26
S12806001	E - 10	10
S12806002	E - 10	10
S12806003	E - 10	10
S12807001	E - 5	10
S12810009	Z2 - 44	30
S12811000	E - 14	10
S12814000	E - 16	10
S12817000	E - 17	10
S12818001	E - 19	10
S12819201	F - 1	12
S12821001	F - 1-2	12
	K - 1-4	20
S12822001	L - 31	24
S12825000	F - 4	12
S12826100	F - 5	12
S12827000	F - 6	12
S12828000	F - 7	12
S12829001	F - 9	12
S12830001	F - 11	12
S12831001	F - 13	12
S12832001	F - 14	12
S12833001	F - 15	12
S12834001	F - 17	12
S12835001	F - 18	12
S12836001	F - 20	12
S12837001	F - 22	12
S12838001	F - 23	12
S12839001	F - 25	12
S12840001	F - 26	12
S12842001	F - 28	12
S12843001	F - 30	12
S12844001	F - 32	12
S12845001	G - 20	14
S12846001	G - 24	14
S12848001	G - 35	14
S12851101	J - 1	18
S12857000	J - 5	18
S12858000	J - 6	18
S12859001	J - 8	18
S12860001	J - 10	18
	J - 15	18
S12861000	J - 13	18
S12862000	J - 14	18
S12863001	J - 16	18

索引/INDEX/VERZEICHIS/
INDEX/INDICE

CODE	REF.NO.	Page
S12864001	J - 18	18
S12865001	J - 19	18
S12866001	J - 20	18
S12871009	H - 5	16
S12872001	H - 16	16
S12873009	H - 21	16
S12874001	H - 27	16
S12875101	H - 30	16
S12876001	H - 30-1	16
S12878001	H - 39	16
S12879001	H - 42	16
S12880001	H - 46	16
S12881001	H - 48	16
S12882001	H - 50	16
S12883001	H - 53	16
S12884001	H - 55	16
S12886000	H - 59	16
S12887001	H - 60	16
S12888001	H - 62	16
S12889001	H - 65	16
S12890001	H - 66	16
S12891001	Z1 - 6	28
S12893009	Z1 - 34-2	28
S12894001	Z1 - 41	28
S12896101	L - 10	24
S12898001	L - 22	24
S12900001	K - 29-5	20
	L - 22-6	24
S12904001	L - 40	24
S12906001	L - 43	24
S12907001	L - 45	24
S12908001	L - 49	24
S12909001	L - 56	24
S12910001	L - 58	24
S12911001	L - 60	24
S12912001	L - 66	24
S12913201	K - 1-1	20
S12915001	K - 1-2	20
S12916001	K - 1-3	20
S12917001	K - 7	20
S12918000	K - 11	20
S12919001	K - 12	20
S12920001	K - 14	20
S12921001	K - 15	20
S12922001	K - 16	20
S12923001	K - 18	20
S12924001	K - 21	20
S12927001	K - 23	20
S12933001	K - 26	20
S12934101	K - 29	20
S12936001	K - 30	20
S12937101	K - 32	20
S12938001	K - 34	20
S12939001	K - 36	20
S12940101	K - 37	20
S12941001	L - 50	24
S12942001	K - 40	20
S12943001	K - 42	20
S12944001	K - 43	20
S12945001	K - 44	20
S12946001	K - 48	22
S12948001	K - 57	22
S12949001	K - 59	22
S12950001	K - 61	22
S12951001	K - 63	22

CODE	REF.NO.	Page
S12952001	K - 66	22
S12953001	K - 69	22
S12954001	K - 71	22
S12955000	K - 73	22
S12956001	K - 74	22
S12957001	K - 75	22
S12958000	K - 77	22
S12959000	K - 78	22
	K - 78	22
S12961001	A - 14	2
S12987001	G - 30	14
S13172001	Z2 - 44-23	30
S13173009	Z2 - 44-6	30
S13174009	Z2 - 44-6-1	30
S13175001	Z2 - 44-7	30
S13176001	Z2 - 44-7-1	30
S13414201	K - 1	20
S13415101	K - 29-1	20
S13583009	Z1 - 35	28
S13666009	Z2 - 44-18	30
S13794001	Z2 - 44-4	30
S13811009	A - 12	2
S13813001	D - 36	8
S13814001	F - 36	12
S13817001	A - 27	2
S14170101	D - 38	8
S14172001	K - 55	22
S14185001	D - 31	8
S14195000	A - 70	2
S14196000	A - 71	2
S14197000	A - 72	2
S14198001	H - 57	16
S14314001	D - 39	8
S14621001	B - 1-2	4
S14622001	E - 1-2	10
S14623001	E - 11-2	10
S15160001	Z2 - 58-1	30
S15165001	A - 30-2	2
S15166009	A - 73	2
S16226000	B - 26	4
S16257001	L - 38	24
S16258001	L - 37	24
S16466000	L - 70	24
S16498001	D - 1-1	8
S17773001	K - 2	20
S18574001	N - 5-1	26
S18575001	N - 5-2	26
S18576001	N - 5-3	26
S18635001	N - 5	26
S18953001	L - 22-1	24
S21331001	Z2 - 58	30
S21332001	Z2 - 58-2	30
S21333001	Z2 - 58-3	30
S21754001	F - 34	12
S25098001	Z1 - 22	28
S28256001	K - 24	20
S28268001	K - 60	22
S28333001	K - 50	22
S28875000	K - 73	22
S28876000	K - 77	22
S30086001	B - 17-4	4
S30564000	H - 14	16
S30565001	H - 18	16
S30565002	H - 20	16

CODE	REF.NO.	Page
S30565003	H - 17	16
S30565004	H - 19	16
S31012001	C - 16	6
S31013001	C - 17	6
0A1501406	Z2 - 44-10-5	30
	Z2 - 44-11-5	30
0A1503006	Z2 - 44-10-4	30
	Z2 - 44-11-4	30
	Z2 - 44-19-2	30
014060632	Z2 - 44-22	30
014680422	D - 30	8
	H - 4	16
	H - 47	16
	J - 11	18
	J - 17	18
	K - 9	20
	K - 70	22
	K - 72	22
	K - 83	22
	L - 47	24
	L - 51	24
	L - 59	24
	L - 61	24
014680622	D - 29	8
	D - 31-2	8
	F - 1-1	12
	G - 18	14
	H - 57-1	16
	K - 56	22
014760622	B - 16	4
	C - 23	6
	F - 10-1	12
	K - 1-1-4	20
	K - 41	20
	L - 22-1-1	24
014770622	B - 2	4
	B - 5	4
	B - 7	4
	B - 14	4
	D - 36-1	8
	E - 9	10
	E - 12	10
	G - 2	14
	H - 30-1-1	16
	K - 3	20
	K - 45	22
014780622	E - 2	10
	L - 27	24
017681012	K - 68	22
017771612	J - 2	18
017781412	G - 4	14
018060822	A - 13	2
018061422	L - 29	24
	L - 41	24
018061622	D - 7	8
	F - 3	12
	F - 12	12
	J - 9	18
	K - 13	20
018062022	J - 21	18
	L - 33	24
	L - 34	24
018081622	A - 58	2
018301222	F - 27	12

索引/INDEX/VERZEICHIS/
INDEX/INDICE

CODE	REF.NO.	Page
018401422	H -30-2-1	16
	J -1-2	18
018771432	C -10	6
	E -7	10
	H -31	16
	H -40	16
	K -2-1	20
021080106	Z1 -28	28
021400106	Z2 -18	30
021500106	Z2 -44-5-3	30
	Z2 -44-10-3	30
	Z2 -44-11-3	30
	Z2 -44-15-3	30
	Z2 -44-19-3	30
021680212	A -40	2
025060132	F -19	12
025080236	Z1 -26	28
025350132	A -42	2
025350332	G -3-2	14
025770232	L -54	24
028050242	Z2 -44-7-3	30
028050246	Z2 -44-10-2	30
	Z2 -44-11-2	30
028060242	L -23	24
028080242	Z1 -27	28
031452206	Z2 -44-15-4	30
047400842	K -54	22
048030342	L -64	24
048040342	D -9	8
048050342	F -16	12
048090142	K -25	20
048110142	D -15	8
048150143	D -1-12	8
060660512	F -31	12
	H -56	16
060670612	H -54	16
060680712	C -3	6
	H -28	16
	H -43	16
	L -67	24
	Z1 -31	28
	Z1 -42	28
062401406	Z2 -19	30
062501006	Z2 -44-15-2	30
062501406	Z2 -44-5-2	30
062502002	Z2 -44-7-2	30
062630612	F -1-3	12
	K -1-5	20
062660512	D -1-8	8
062660712	B -31	4
062670412	A -43	2
062670612	B -23	4
	G -9	14
	G -11	14
	G -15	14
	G -21	14
	G -36	14
	G -41	14
	H -45	16
	K -38	20
	L -6	24
	L -21	24
062670812	D -21	8

CODE	REF.NO.	Page
062670812	E -21	10
	G -3-3	14
062671012	G -3-8	14
062671212	N -5-6	26
062680512	B -33	4
062680612	A -51	2
	E -4	10
	H -51	16
062680812	A -26	2
	A -28	2
	B -29	4
	G -31	14
	H -2	16
	L -57	24
062681012	A -4	2
	A -32	2
	H -6	16
	N -5-4	26
	Z1 -57	28
062681212	H -26	16
062681412	C -28	6
	L -2	24
062681612	A -16	2
062711012	B -10	4
062780812	G -38	14
072600000	E -18	10
081003670	D -12	8
081014670	A -6	2
081044070	G -34	14
081046870	B -12	4
100025002	D -1-17	8
100064005	B -17-4-2	4
100136001	L -55	24
100251001	D -5	8
100294002	M -5-3	26
100366002	M -10	26
100526003	K -21-1	20
101572101	Z1 -2	28
101671002	H -52	16
102023005	Z1 -56	28
102424004	Z1 -39	28
102538002	K -76	22
102630001	B -24	4
102843004	A -20	2
	A -35	2
	L -22-2	24
103810002	K -82	22
104449009	A -21	2
104464001	B -13	4
104821009	A -53	2
105161004	K -1-1-3	20
105343001	Z1 -11	28
105812003	K -28	20
	L -69	24
106128004	K -31	20
	K -35	20
	L -16	24
	L -25	24
106588003	K -53	22
106629002	A -49	2
107017002	K -64	22
107093002	M -7	26
107153001	B -19	4
	K -80	22

CODE	REF.NO.	Page
107272002	K -79	22
107453001	K -19	20
	L -8	24
107780001	Z1 -13	28
109203001	A -60	2
109239001	K -49	22
109763002	L -48	24
109893002	F -38	12
110140001	K -20	20
	K -22	20
110167001	K -46	22
110168001	K -47	22
110197001	L -35	24
110641002	A -59	2
110778002	L -9	24
110793001	C -7	6
110813001	H -9	16
110820101	L -52	24
110832009	H -11	16
112359001	G -28	14
112364001	G -22	14
	G -25	14
112467002	G -3-11	14
112684001	E -13	10
112700001	K -52	22
112743001	G -8	14
113431002	H -68	16
113644001	K -1-1-1	20
113730001	Z1 -37	28
116016001	Z2 -20	30
116662004	L -13	24
117143003	A -31	2
117466000	Z1 -14	28
117516001	A -46	2
	H -67	16
	K -58	22
	N -5-7	26
117517003	D -1-16	8
117934009	A -18	2
118718001	H -24	16
118735002	L -28	24
118770001	G -12	14
118837001	Z1 -3	28
118853001	B -15	4
	K -29-1-1	20
	L -22-1-2	24
120265001	A -39	2
121007001	K -33	20
122991001	Z1 -45	28
126863001	Z2 -44-14	30
129984002	Z1 -36	28
131007001	Z2 -44-6-2	30
138201001	Z1 -10	28
138843001	Z2 -44-21	30
140066009	A -23	2
140092001	K -8	20
140165001	D -1-3	8
140176001	D -1-15	8
140326009	D -4	8
140327001	D -16	8
140407001	C -19	6
140759000	Z1 -32	28
140779101	G -27	14

索引/INDEX/VERZEICHIS/
INDEX/INDICE

CODE	REF.NO.	Page
141208001	C -20	6
141404000	D -18	8
141544001	F -33	12
141728001	C -18	6
142359001	G -5	14
142628001	D -14	8
	F -37	12
142721001	Z1 -7	28
143312000	E -20	10
143325001	C -5	6
143602001	H -29	16
144055001	D -1-10	8
144075001	K -1-1-2	20
144103009	H -12	16
144104001	H -15	16
144224001	Z1 -33	28
144619000	G -3-1	14
144622001	G -3-5	14
144875001	G -3-9	14
144876001	G -3-10	14
145277105	Z1 -16	28
145446001	H -13	16
145472001	C -21	6
145663001	D -1-2	8
145688000	B -22	4
145737001	G -7	14
146049001	Z1 -5	28
146354001	N -5-5	26
146401001	D -1-4	8
146402001	D -1-5	8
146403001	D -1-6	8
146404001	D -1-7	8
146427001	M -1-1	26
	M -8-1	26
146529001	D -1-11	8
146531001	D -1-14	8
146532001	D -2	8
146539000	D -17	8
146598001	Z1 -38	28
146688001	L -53	24
147318000	D -3	8
147476001	F -21	12
147527000	G -3-7	14
147528100	G -3-12	14
147529000	G -3-13	14
147691000	D -35	8
	H -64	16
	L -42	24
147893009	Z2 -17	30
147919001	Z1 -29	28
148007001	L -14	24
148042001	L -65	24
	Z1 -40	28
148084001	A -29	2
148120000	K -10	20
148121000	K -6	20
148239001	L -39	24
148271001	H -61	16
148294001	D -31-1	8
	F -29	12
	H -63	16
	K -17	20
	L -44	24

CODE	REF.NO.	Page
148372001	C -4	6
148403001	J -12	18
148847001	K -67	22
149247001	Z1 -21	28
150106003	Z2 -44-5	30
150145009	Z2 -44-19	30
150172003	Z2 -44-2	30
150173003	Z2 -44-5-1	30
150174000	Z2 -44-3	30
150179002	Z2 -44-10-1	30
	Z2 -44-11-1	30
150180001	Z2 -44-12	30
150182000	Z2 -44-13	30
150185009	Z2 -44-19-1	30
150188009	Z2 -44-15-1	30
150191002	Z2 -44-4-2	30
150206000	Z2 -44-4-1	30
150335001	Z1 -8	28
150604101	K -29-3	20
	L -22-4	24
150605001	K -29-4	20
	L -22-5	24
150645009	H -3	16
150756009	A -54	2
151059001	A -55	2
151090001	D -28	8
	L -18	24
151429001	G -10	14
151927001	G -42	14
152718001	B -20	4
	F -34-1	12
	J -4-1	18
153484001	D -11	8
153675001	J -1-1	18
	L -36	24
	M -1-2	26
153734001	E -3	10
154596000	C -24	6
154631001	A -38	2
154886001	E -6	10
154892000	K -39	20
154956001	C -9	6
154957001	C -11	6
155145000	D -20	8
155162001	H -41	16
155220000	C -8	6
	H -32	16
155247000	D -23	8
155294100	G -39	14
155295001	G -40	14
155539000	C -13	6
	H -38	16
156112003	Z2 -44-1	30
156265001	K -81	22
157840000	G -16	14
158384001	A -76	2
159093009	K -51	22
159113001	F -24	12
159150009	A -7	2
159441001	F -10	12
	J -4	18
159476000	G -23	14
	G -26	14

CODE	REF.NO.	Page
159476000	G -29	14
159574101	H -10	16
213650001	Z1 -25	28
222372001	Z1 -24	28

brother®

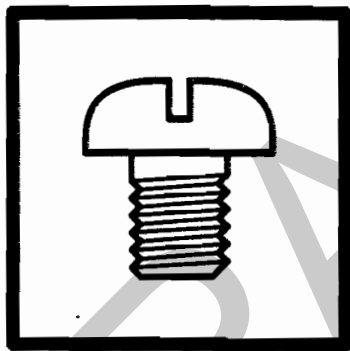

MAINTENANCE PARTS

パーツブック
PARTS BOOK
TEILEKATALOG
LIVRE DES PIECES
LIBRO DE REFERENCIA DE PIEZAS

ブラザー工業株式会社

BROTHER INDUSTRIES, LTD.

〒467 名古屋市瑞穂区河岸1丁目1番1号 TEL(052)824-2392(代)

Printed in Japan/Gedruckt in Japan /Imprimé au Japon/Impreso en Japón

118-281
195281-401
1994, 03